

## Introduction

This programming manual provides information for application and system-level software developers. It gives a full description of the STM32F3 and STM32F4 Series Cortex<sup>®</sup>-M4 processor programming model, instruction set and core peripherals.

The STM32F3 and STM32F4 Series Cortex<sup>®</sup>-M4 processor is a high performance 32-bit processor designed for the microcontroller market. It offers significant benefits to developers, including:

- Outstanding processing performance combined with fast interrupt handling
- Enhanced system debug with extensive breakpoint and trace capabilities
- Efficient processor core, system and memories
- Ultra-low power consumption with integrated sleep modes
- Platform security

## Reference documents

- STM32F3 and STM32F4 Series datasheets.
- STM32F405xx/07xx, STM32F415xx/17xx, STM32F42xxx and STM32F43xxx advanced ARM<sup>®</sup>-based 32-bit MCU (RM0090).
- STM32F401xB/C and STM32F401xD/E advanced ARM<sup>®</sup>-based 32-bit MCU (RM0368)
- STM32F37xx advanced ARM<sup>®</sup>-based 32-bit MCUs (RM0313).
- STM32F303xB/C, STM32F303x6/8, STM32F328x8 and STM32F358xC advanced ARM<sup>®</sup>-based 32-bit MCUs (RM0316).

The documents listed above are available on [www.st.com](http://www.st.com).

This programming manual applies to the products listed in [Table 1](#).

**Table 1. Applicable products**

Type	Part numbers
Microcontrollers	STM32F3 Series STM32F4 Series

# Contents

- 1 About this document . . . . . 12**
  - 1.1 Typographical conventions . . . . . 12
  - 1.2 List of abbreviations for registers . . . . . 12
  - 1.3 About the STM32 Cortex-M4 processor and core peripherals . . . . . 13
    - 1.3.1 System level interface . . . . . 14
    - 1.3.2 Integrated configurable debug . . . . . 14
    - 1.3.3 Cortex-M4 processor features and benefits summary . . . . . 14
    - 1.3.4 Cortex-M4 core peripherals . . . . . 15
  
- 2 The Cortex-M4 processor . . . . . 16**
  - 2.1 Programmers model . . . . . 16
    - 2.1.1 Processor mode and privilege levels for software execution . . . . . 16
    - 2.1.2 Stacks . . . . . 16
    - 2.1.3 Core registers . . . . . 17
    - 2.1.4 Exceptions and interrupts . . . . . 25
    - 2.1.5 Data types . . . . . 25
    - 2.1.6 The Cortex microcontroller software interface standard (CMSIS) . . . . . 25
  - 2.2 Memory model . . . . . 27
    - 2.2.1 Memory regions, types and attributes . . . . . 28
    - 2.2.2 Memory system ordering of memory accesses . . . . . 28
    - 2.2.3 Behavior of memory accesses . . . . . 29
    - 2.2.4 Software ordering of memory accesses . . . . . 30
    - 2.2.5 Bit-banding . . . . . 31
    - 2.2.6 Memory endianness . . . . . 33
    - 2.2.7 Synchronization primitives . . . . . 33
    - 2.2.8 Programming hints for the synchronization primitives . . . . . 35
  - 2.3 Exception model . . . . . 36
    - 2.3.1 Exception states . . . . . 36
    - 2.3.2 Exception types . . . . . 36
    - 2.3.3 Exception handlers . . . . . 38
    - 2.3.4 Vector table . . . . . 39
    - 2.3.5 Exception priorities . . . . . 40
    - 2.3.6 Interrupt priority grouping . . . . . 40
    - 2.3.7 Exception entry and return . . . . . 41



2.4	Fault handling	43
2.4.1	Fault types	44
2.4.2	Fault escalation and hard faults	45
2.4.3	Fault status registers and fault address registers	46
2.4.4	Lockup	46
2.5	Power management	46
2.5.1	Entering sleep mode	47
2.5.2	Wakeup from sleep mode	47
2.5.3	External event input / extended interrupt and event input	48
2.5.4	Power management programming hints	48
<b>3</b>	<b>The STM32 Cortex-M4 instruction set</b>	<b>49</b>
3.1	Instruction set summary	49
3.2	CMSIS intrinsic functions	57
3.3	About the instruction descriptions	59
3.3.1	Operands	59
3.3.2	Restrictions when using PC or SP	59
3.3.3	Flexible second operand	59
3.3.4	Shift operations	61
3.3.5	Address alignment	64
3.3.6	PC-relative expressions	64
3.3.7	Conditional execution	64
3.3.8	Instruction width selection	67
3.4	Memory access instructions	68
3.4.1	ADR	69
3.4.2	LDR and STR, immediate offset	70
3.4.3	LDR and STR, register offset	72
3.4.4	LDR and STR, unprivileged	73
3.4.5	LDR, PC-relative	74
3.4.6	LDM and STM	75
3.4.7	PUSH and POP	77
3.4.8	LDREX and STREX	78
3.4.9	CLREX	79
3.5	General data processing instructions	80
3.5.1	ADD, ADC, SUB, SBC, and RSB	82
3.5.2	AND, ORR, EOR, BIC, and ORN	84

3.5.3	ASR, LSL, LSR, ROR, and RRX	85
3.5.4	CLZ	86
3.5.5	CMP and CMN	87
3.5.6	MOV and MVN	88
3.5.7	MOVT	90
3.5.8	REV, REV16, REVSH, and RBIT	91
3.5.9	SADD16 and SADD8	92
3.5.10	SHADD16 and SHADD8	93
3.5.11	SHASX and SHSAX	94
3.5.12	SHSUB16 and SHSUB8	95
3.5.13	SSUB16 and SSUB8	96
3.5.14	SASX and SSAX	97
3.5.15	TST and TEQ	98
3.5.16	UADD16 and UADD8	99
3.5.17	UASX and USAX	100
3.5.18	UHADD16 and UHADD8	101
3.5.19	UHASX and UHSAX	102
3.5.20	UHSUB16 and UHSUB8	103
3.5.21	SEL	104
3.5.22	USAD8	105
3.5.23	USADA8	106
3.5.24	USUB16 and USUB8	107
3.6	Multiply and divide instructions	108
3.6.1	MUL, MLA, and MLS	109
3.6.2	UMULL, UMAAL and UMLAL	110
3.6.3	SMLA and SMLAW	111
3.6.4	SMLAD	113
3.6.5	SMLAL and SMLALD	114
3.6.6	SMLSD and SMLSLD	116
3.6.7	SMMLA and SMMLS	118
3.6.8	SMMUL	119
3.6.9	SMUAD and SMUSD	120
3.6.10	SMUL and SMULW	121
3.6.11	UMULL, UMLAL, SMULL, and SMLAL	122
3.6.12	SDIV and UDIV	123
3.7	Saturating instructions	124
3.7.1	SSAT and USAT	125

3.7.2	SSAT16 and USAT16	126
3.7.3	QADD and QSUB	127
3.7.4	QASX and QSAX	128
3.7.5	QDADD and QDSUB	129
3.7.6	UQASX and UQSAX	130
3.7.7	UQADD and UQSUB	131
3.8	Packing and unpacking instructions	132
3.8.1	PKHBT and PKHTB	133
3.8.2	SXT and UXT	134
3.8.3	SXTA and UXTA	135
3.9	Bitfield instructions	136
3.9.1	BFC and BFI	137
3.9.2	SBFX and UBFX	138
3.9.3	SXT and UXT	139
3.9.4	Branch and control instructions	140
3.9.5	B, BL, BX, and BLX	141
3.9.6	CBZ and CBNZ	143
3.9.7	IT	144
3.9.8	TBB and TBH	146
3.10	Floating-point instructions	148
3.10.1	VABS	149
3.10.2	VADD	150
3.10.3	VCMP, VCMPE	150
3.10.4	VCVT, VCVTR between floating-point and integer	151
3.10.5	VCVT between floating-point and fixed-point	152
3.10.6	VCVTB, VCVTT	153
3.10.7	VDIV	154
3.10.8	VFMA, VFMS	154
3.10.9	VFNMA, VFNMS	155
3.10.10	VLDM	156
3.10.11	VLDR	157
3.10.12	VLMA, VLMS	158
3.10.13	VMOV immediate	158
3.10.14	VMOV register	159
3.10.15	VMOV scalar to ARM core register	159
3.10.16	VMOV ARM core register to single precision	160
3.10.17	VMOV two ARM core registers to two single precision	161

3.10.18	VMOV ARM Core register to scalar	162
3.10.19	VMRS	162
3.10.20	VMSR	163
3.10.21	VMUL	163
3.10.22	VNEG	164
3.10.23	VNMLA, VNMLS, VNMUL	165
3.10.24	VPOP	166
3.10.25	VPUSH	166
3.10.26	VSQRT	167
3.10.27	VSTM	167
3.10.28	VSTR	168
3.10.29	VSUB	169
3.11	Miscellaneous instructions	170
3.11.1	BKPT	170
3.11.2	CPS	171
3.11.3	DMB	172
3.11.4	DSB	172
3.11.5	ISB	173
3.11.6	MRS	173
3.11.7	MSR	174
3.11.8	NOP	175
3.11.9	SEV	175
3.11.10	SVC	176
3.11.11	WFE	176
3.11.12	WFI	177
<b>4</b>	<b>Core peripherals</b>	<b>178</b>
4.1	About the STM32 Cortex-M4 core peripherals	178
4.2	Memory protection unit (MPU)	178
4.2.1	MPU access permission attributes	180
4.2.2	MPU mismatch	181
4.2.3	Updating an MPU region	181
4.2.4	MPU design hints and tips	184
4.2.5	MPU type register (MPU_TYPER)	185
4.2.6	MPU control register (MPU_CTRL)	186
4.2.7	MPU region number register (MPU_RNR)	187
4.2.8	MPU region base address register (MPU_RBAR)	188

4.2.9	MPU region attribute and size register (MPU_RASR) . . . . .	189
4.2.10	MPU register map . . . . .	191
4.3	Nested vectored interrupt controller (NVIC) . . . . .	193
4.3.1	Accessing the Cortex-M4 NVIC registers using CMSIS . . . . .	194
4.3.2	Interrupt set-enable registers (NVIC_ISERx) . . . . .	195
4.3.3	Interrupt clear-enable registers (NVIC_ICERx) . . . . .	196
4.3.4	Interrupt set-pending registers (NVIC_ISPRx) . . . . .	197
4.3.5	Interrupt clear-pending registers (NVIC_ICPRx) . . . . .	198
4.3.6	Interrupt active bit registers (NVIC_IABRx) . . . . .	199
4.3.7	Interrupt priority registers (NVIC_IPRx) . . . . .	200
4.3.8	Software trigger interrupt register (NVIC_STIR) . . . . .	201
4.3.9	Level-sensitive and pulse interrupts . . . . .	202
4.3.10	NVIC design hints and tips . . . . .	203
4.3.11	NVIC register map . . . . .	204
4.4	System control block (SCB) . . . . .	206
4.4.1	Auxiliary control register (ACTLR) . . . . .	207
4.4.2	CPUID base register (CPUID) . . . . .	208
4.4.3	Interrupt control and state register (ICSR) . . . . .	210
4.4.4	Vector table offset register (VTOR) . . . . .	212
4.4.5	Application interrupt and reset control register (AIRCR) . . . . .	212
4.4.6	System control register (SCR) . . . . .	214
4.4.7	Configuration and control register (CCR) . . . . .	215
4.4.8	System handler priority registers (SHPRx) . . . . .	217
4.4.9	System handler control and state register (SHCSR) . . . . .	219
4.4.10	Configurable fault status register (CFSR; UFSR+BFSR+MMFSR) . . . . .	221
4.4.11	Usage fault status register (UFSR) . . . . .	222
4.4.12	Bus fault status register (BFSR) . . . . .	223
4.4.13	Memory management fault address register (MMFSR) . . . . .	224
4.4.14	Hard fault status register (HFSR) . . . . .	225
4.4.15	Memory management fault address register (MMFAR) . . . . .	226
4.4.16	Bus fault address register (BFAR) . . . . .	226
4.4.17	Auxiliary fault status register (AFSR) . . . . .	227
4.4.18	System control block design hints and tips . . . . .	227
4.4.19	SCB register map . . . . .	228
4.5	SysTick timer (STK) . . . . .	230
4.5.1	SysTick control and status register (STK_CTRL) . . . . .	231
4.5.2	SysTick reload value register (STK_LOAD) . . . . .	232

---

4.5.3	SysTick current value register (STK_VAL) .....	233
4.5.4	SysTick calibration value register (STK_CALIB) .....	234
4.5.5	SysTick design hints and tips .....	234
4.5.6	SysTick register map .....	235
4.6	Floating point unit (FPU) .....	236
4.6.1	Coprocessor access control register (CPACR) .....	237
4.6.2	Floating-point context control register (FPCCR) .....	237
4.6.3	Floating-point context address register (FPCAR) .....	239
4.6.4	Floating-point status control register (FPSCR) .....	239
4.6.5	Floating-point default status control register (FPDSCR) .....	241
4.6.6	Enabling the FPU .....	241
4.6.7	Enabling and clearing FPU exception interrupts .....	241
<b>5</b>	<b>Revision history .....</b>	<b>244</b>



## List of tables

Table 1.	Applicable products	1
Table 2.	Summary of processor mode, execution privilege level, and stack usage	17
Table 3.	Core register set summary	17
Table 4.	PSR register combinations	19
Table 5.	APSR bit definitions	20
Table 6.	IPSR bit definitions	21
Table 7.	EPSR bit definitions	22
Table 8.	PRIMASK register bit definitions	23
Table 9.	FAULTMASK register bit definitions	23
Table 10.	BASEPRI register bit assignments	24
Table 11.	CONTROL register bit definitions	24
Table 12.	Ordering of memory accesses	28
Table 13.	Memory access behavior	29
Table 14.	SRAM memory bit-banding regions	31
Table 15.	Peripheral memory bit-banding regions	31
Table 16.	CMSIS functions for exclusive access instructions	35
Table 17.	Properties of the different exception types	37
Table 18.	Exception return behavior	43
Table 19.	Faults	44
Table 20.	Fault status and fault address registers	46
Table 21.	Cortex-M4 instructions	49
Table 22.	CMSIS intrinsic functions to generate some Cortex-M4 instructions	58
Table 23.	CMSIS intrinsic functions to access the special registers	58
Table 24.	Condition code suffixes	66
Table 25.	Memory access instructions	68
Table 26.	Immediate, pre-indexed and post-indexed offset ranges	71
Table 27.	<i>label</i> -PC offset ranges	74
Table 28.	Data processing instructions	80
Table 29.	Multiply and divide instructions	108
Table 30.	Saturating instructions	124
Table 31.	Packing and unpacking instructions	132
Table 32.	Instructions that operate on adjacent sets of bits	136
Table 33.	Branch and control instructions	140
Table 34.	Branch ranges	141
Table 35.	Floating-point instructions	148
Table 36.	Miscellaneous instructions	170
Table 37.	STM32 core peripheral register regions	178
Table 38.	Memory attributes summary	179
Table 39.	TEX, C, B, and S encoding	180
Table 40.	Cache policy for memory attribute encoding	180
Table 41.	AP encoding	181
Table 42.	Memory region attributes for STM32	184
Table 43.	Example SIZE field values	190
Table 44.	MPU register map and reset values	191
Table 45.	NVIC register summary	193
Table 46.	CMSIS access NVIC functions	194
Table 47.	IPR bit assignments	200
Table 48.	CMSIS functions for NVIC control	203

---

Table 49.	NVIC register map and reset values . . . . .	204
Table 50.	Summary of the system control block registers . . . . .	206
Table 51.	Priority grouping . . . . .	213
Table 52.	System fault handler priority fields . . . . .	217
Table 53.	SCB register map and reset values . . . . .	228
Table 54.	System timer registers summary . . . . .	230
Table 55.	SysTick register map and reset values . . . . .	235
Table 56.	Cortex-M4F floating-point system registers . . . . .	236
Table 57.	Effect of a Floating-point comparison on the condition flags . . . . .	240
Table 58.	Document revision history . . . . .	244

## List of figures

Figure 1.	STM32 Cortex-M4 implementation . . . . .	13
Figure 2.	Processor core registers . . . . .	17
Figure 3.	APSR, IPSR and EPSR bit assignments . . . . .	19
Figure 4.	PSR bit assignments . . . . .	19
Figure 5.	PRIMASK bit assignments . . . . .	23
Figure 6.	FAULTMASK bit assignments . . . . .	23
Figure 7.	BASEPRI bit assignments . . . . .	24
Figure 8.	Memory map . . . . .	27
Figure 9.	Bit-band mapping . . . . .	32
Figure 10.	Little-endian example . . . . .	33
Figure 11.	Vector table . . . . .	39
Figure 12.	Cortex-M4 stack frame layout . . . . .	42
Figure 13.	ASR#3 . . . . .	61
Figure 14.	LSR#3 . . . . .	62
Figure 15.	LSL#3 . . . . .	62
Figure 16.	ROR #3 . . . . .	63
Figure 17.	RRX #3 . . . . .	63
Figure 18.	Subregion example . . . . .	183
Figure 19.	NVIC_IPRx register mapping . . . . .	200
Figure 20.	CFSR subregisters . . . . .	221

# 1 About this document

This document provides the information required for application and system-level software development. It does not provide information on debug components, features, or operation.

This material is for microcontroller software and hardware engineers, including those who have no experience of ARM products.

## 1.1 Typographical conventions

The typographical conventions used in this document are:

<i>italic</i>	Highlights important notes, introduces special terminology, denotes internal cross-references, and citations.
< and >	Enclose replaceable terms for assembler syntax where they appear in code or code fragments. For example: LDRSB<cond> <Rt>, [<Rn>, #<offset>]
<b>bold</b>	Highlights interface elements, such as menu names. Denotes signal names. Also used for terms in descriptive lists, where appropriate.
monospace	Denotes text that you can enter at the keyboard, such as commands, file and program names, and source code.
<u>monospace</u>	Denotes a permitted abbreviation for a command or option. You can enter the underlined text instead of the full command or option name.
<i>monospace italic</i>	Denotes arguments to monospace text where the argument is to be replaced by a specific value.
<b>monospace bold</b>	Denotes language keywords when used outside example code.

## 1.2 List of abbreviations for registers

The following abbreviations are used in register descriptions:

read/write (rw)	Software can read and write to these bits.
read-only (r)	Software can only read these bits.
write-only (w)	Software can only write to this bit. Reading the bit returns the reset value.
read/clear (rc_w1)	Software can read as well as clear this bit by writing 1. Writing '0' has no effect on the bit value.
read/clear (rc_w0)	Software can read as well as clear this bit by writing 0. Writing '1' has no effect on the bit value.
toggle (t)	Software can only toggle this bit by writing '1'. Writing '0' has no effect.
Reserved (Res.)	Reserved bit, must be kept at reset value.

### 1.3 About the STM32 Cortex-M4 processor and core peripherals

The Cortex-M4 processor is a high performance 32-bit processor designed for the microcontroller market. It offers significant benefits to developers, including:

- outstanding processing performance combined with fast interrupt handling
- enhanced system debug with extensive breakpoint and trace capabilities
- efficient processor core, system and memories
- ultra-low power consumption with integrated sleep modes
- platform security robustness, with integrated memory protection unit (MPU).

The Cortex-M4 processor is built on a high-performance processor core, with a 3-stage pipeline Harvard architecture, making it ideal for demanding embedded applications. The processor delivers exceptional power efficiency through an efficient instruction set and extensively optimized design, providing high-end processing hardware including IEEE754-compliant single-precision floating-point computation, a range of single-cycle and SIMD multiplication and multiply-with-accumulate capabilities, saturating arithmetic and dedicated hardware division.

**Figure 1. STM32 Cortex-M4 implementation**

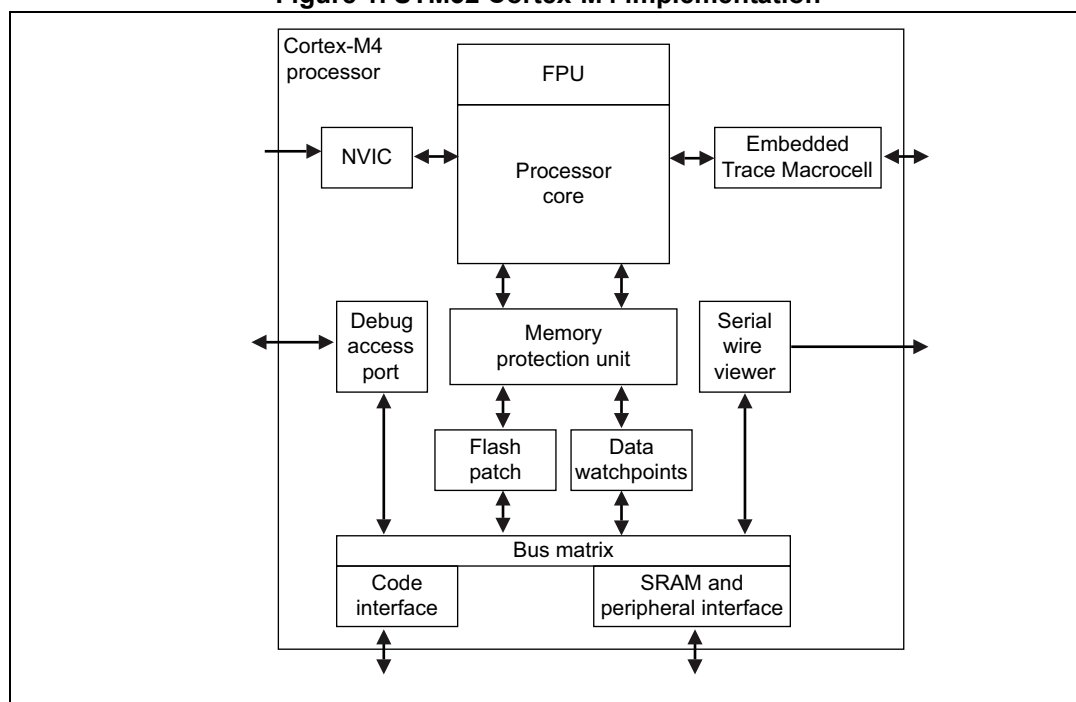

To facilitate the design of cost-sensitive devices, the Cortex-M4 processor implements tightly-coupled system components that reduce processor area while significantly improving interrupt handling and system debug capabilities. The Cortex-M4 processor implements a version of the Thumb<sup>®</sup> instruction set based on Thumb-2 technology, ensuring high code density and reduced program memory requirements. The Cortex-M4 instruction set provides the exceptional performance expected of a modern 32-bit architecture, with the high code density of 8-bit and 16-bit microcontrollers.

The Cortex-M4 processor closely integrates a configurable nested interrupt controller (NVIC), to deliver industry-leading interrupt performance. The NVIC includes a non-maskable interrupt (NMI), and provides up to 256 interrupt priority levels. The tight

integration of the processor core and NVIC provides fast execution of interrupt service routines (ISRs), dramatically reducing the interrupt latency. This is achieved through the hardware stacking of registers, and the ability to suspend load-multiple and store-multiple operations. Interrupt handlers do not require any assembler stubs, removing any code overhead from the ISRs. Tail-chaining optimization also significantly reduces the overhead when switching from one ISR to another.

To optimize low-power designs, the NVIC integrates with the sleep modes, that include a deep sleep function that enables the STM32 to enter STOP or STDBY mode.

### 1.3.1 System level interface

The Cortex-M4 processor provides multiple interfaces using AMBA® technology to provide high speed, low latency memory accesses. It supports unaligned data accesses and implements atomic bit manipulation that enables faster peripheral controls, system spinlocks and thread-safe Boolean data handling.

The Cortex-M4 processor has a memory protection unit (MPU) that provides fine grain memory control, enabling applications to utilize multiple privilege levels, separating and protecting code, data and stack on a task-by-task basis. Such requirements are critical in many embedded applications such as automotive.

### 1.3.2 Integrated configurable debug

The Cortex-M4 processor implements a complete hardware debug solution. This provides high system visibility of the processor and memory through either a traditional JTAG port or a 2-pin *Serial Wire Debug* (SWD) port that is ideal for small package devices.

For system trace the processor integrates an *Instrumentation Trace Macrocell* (ITM) alongside data watchpoints and a profiling unit. To enable simple and cost-effective profiling of the system events these generate, a *Serial Wire Viewer* (SWV) can export a stream of software-generated messages, data trace, and profiling information through a single pin.

The optional *Embedded Trace Macrocell*™ (ETM) delivers unrivalled instruction trace capture in an area far smaller than traditional trace units.

### 1.3.3 Cortex-M4 processor features and benefits summary

- Tight integration of system peripherals reduces area and development costs
- Thumb instruction set combines high code density with 32-bit performance
- IEEE754-compliant single-precision FPU implemented in all STM32F4xxx and STM32F3xxx Cortex-M4 microcontrollers
- Power control optimization of system components
- Integrated sleep modes for low power consumption
- Fast code execution permits slower processor clock or increases sleep mode time
- Hardware division and fast multiplier
- Deterministic, high-performance interrupt handling for time-critical applications
- Memory protection unit (MPU) for safety-critical applications
- Extensive debug and trace capabilities: Serial Wire Debug and Serial Wire Trace reduce the number of pins required for debugging and tracing.

### 1.3.4 Cortex-M4 core peripherals

The peripherals are:

#### **Nested vectored interrupt controller**

The *nested vectored interrupt controller* (NVIC) is an embedded interrupt controller that supports low latency interrupt processing.

#### **System control block**

The *system control block* (SCB) is the programmers model interface to the processor. It provides system implementation information and system control, including configuration, control, and reporting of system exceptions.

#### **System timer**

The system timer, SysTick, is a 24-bit count-down timer. Use this as a Real Time Operating System (RTOS) tick timer or as a simple counter.

#### **Memory protection unit**

The *Memory protection unit* (MPU) improves system reliability by defining the memory attributes for different memory regions. It provides up to eight different regions, and an optional predefined background region.

#### **Floating-point unit**

The *Floating-point unit* (FPU) provides IEEE754-compliant operations on single-precision, 32-bit, floating-point values.

## 2 The Cortex-M4 processor

### 2.1 Programmers model

This section describes the Cortex-M4 programmers model. In addition to the individual core register descriptions, it contains information about the processor modes and privilege levels for software execution and stacks.

#### 2.1.1 Processor mode and privilege levels for software execution

The processor *modes* are:

Thread mode: Used to execute application software.

The processor enters Thread mode when it comes out of reset.

The CONTROL register controls whether software execution is privileged or unprivileged, see [CONTROL register on page 24](#).

Handler mode: Used to handle exceptions.

The processor returns to Thread mode when it has finished exception processing.

Software execution is always privileged.

The *privilege levels* for software execution are:

**Unprivileged:** *Unprivileged software* executes at the unprivileged level and:

- Has limited access to the MSR and MRS instructions, and cannot use the CPS instruction
- Cannot access the system timer, NVIC, or system control block
- Might have restricted access to memory or peripherals
- Must use the SVC instruction to make a *supervisor call* to transfer control to privileged software

**Privileged:** *Privileged software* executes at the privileged level and can use all the instructions and has access to all resources.

Can write to the CONTROL register to change the privilege level for software execution.

#### 2.1.2 Stacks

The processor uses a full descending stack. This means the stack pointer indicates the last stacked item on the stack memory. When the processor pushes a new item onto the stack, it decrements the stack pointer and then writes the item to the new memory location. The processor implements two stacks, the *main stack* and the *process stack*, with independent copies of the stack pointer, see [Stack pointer on page 18](#).

In Thread mode, the CONTROL register controls whether the processor uses the main stack or the process stack, see [CONTROL register on page 24](#). In Handler mode, the processor always uses the main stack. The options for processor operations are:



**Table 2. Summary of processor mode, execution privilege level, and stack usage**

Processor mode	Used to execute	Privilege level for software execution	Stack used
Thread	Applications	Privileged or unprivileged <sup>(1)</sup>	Main stack or process stack <sup>(1)</sup>
Handler	Exception handlers	Always privileged	Main stack

1. See [CONTROL register on page 24](#).

### 2.1.3 Core registers

**Figure 2. Processor core registers**

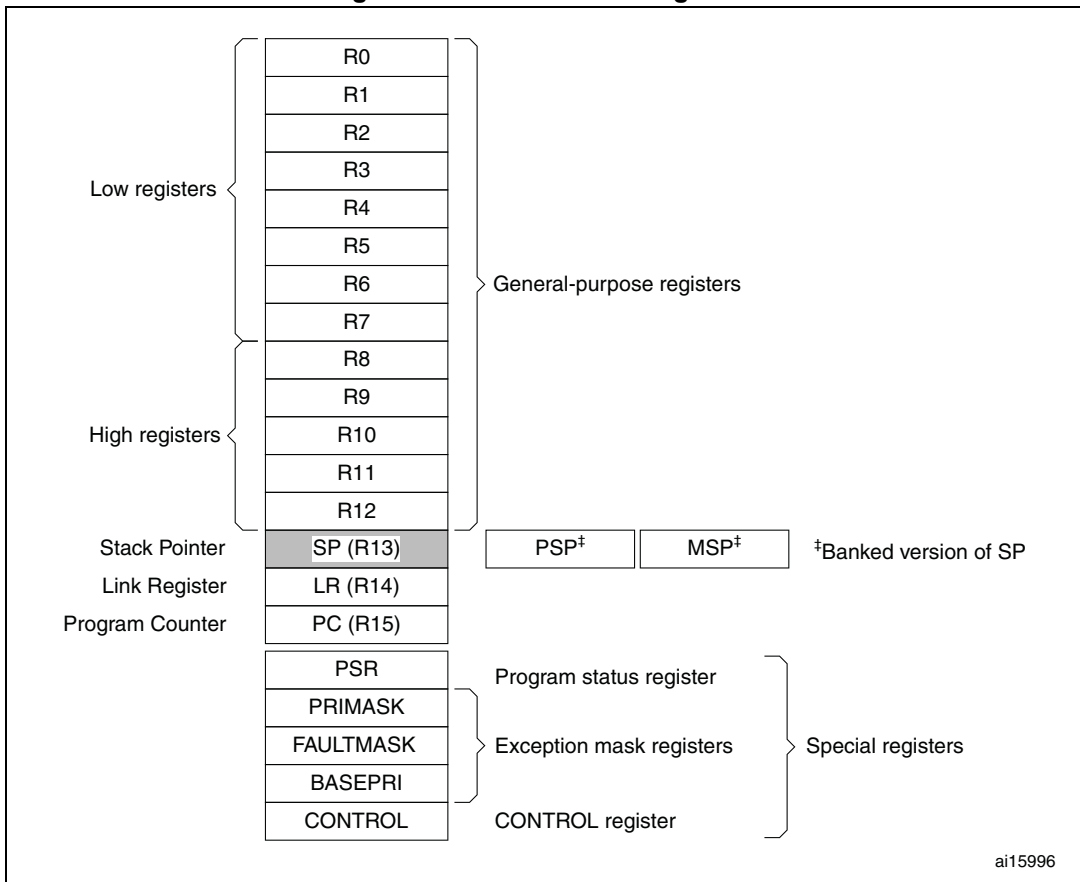

**Table 3. Core register set summary**

Name	Type <sup>(1)</sup>	Required privilege <sup>(2)</sup>	Reset value	Description
R0-R12	read-write	Either	Unknown	<a href="#">General-purpose registers on page 18</a>
MSP	read-write	Privileged	See description	<a href="#">Stack pointer on page 18</a>
PSP	read-write	Either	Unknown	<a href="#">Stack pointer on page 18</a>
LR	read-write	Either	0xFFFFFFFF	<a href="#">Link register on page 18</a>
PC	read-write	Either	See description	<a href="#">Program counter on page 18</a>

**Table 3. Core register set summary (continued)**

Name	Type <sup>(1)</sup>	Required privilege <sup>(2)</sup>	Reset value	Description
PSR	read-write	Privileged	0x01000000	<a href="#">Program status register on page 18</a>
ASPR	read-write	Either	Unknown	<a href="#">Application program status register on page 20</a>
IPSR	read-only	Privileged	0x00000000	<a href="#">Interrupt program status register on page 21</a>
EPSR	read-only	Privileged	0x01000000	<a href="#">Execution program status register on page 21</a>
PRIMASK	read-write	Privileged	0x00000000	<a href="#">Priority mask register on page 23</a>
FAULTMASK	read-write	Privileged	0x00000000	<a href="#">Fault mask register on page 23</a>
BASEPRI	read-write	Privileged	0x00000000	<a href="#">Base priority mask register on page 24</a>
CONTROL	read-write	Privileged	0x00000000	<a href="#">CONTROL register on page 24</a>

1. Describes access type during program execution in thread mode and Handler mode. Debug access can differ.
2. An entry of Either means privileged and unprivileged software can access the register.

### General-purpose registers

R0-R12 are 32-bit general-purpose registers for data operations.

### Stack pointer

The *Stack Pointer* (SP) is register R13. In Thread mode, bit[1] of the CONTROL register indicates the stack pointer to use:

- 0: *Main Stack Pointer* (MSP). This is the reset value.
- 1: *Process Stack Pointer* (PSP).

On reset, the processor loads the MSP with the value from address 0x00000000.

### Link register

The *Link Register* (LR) is register R14. It stores the return information for subroutines, function calls, and exceptions. On reset, the processor loads the LR value 0xFFFFFFFF.

### Program counter

The *Program Counter* (PC) is register R15. It contains the current program address. On reset, the processor loads the PC with the value of the reset vector, which is at address 0x00000004. Bit[0] of the value is loaded into the EPSR T-bit at reset and must be 1.

### Program status register

The *Program Status Register* (PSR) combines:

- *Application Program Status Register* (APSR)
- *Interrupt Program Status Register* (IPSR)
- *Execution Program Status Register* (EPSR)

These registers are mutually exclusive bitfields in the 32-bit PSR. The bit assignments are as shown in [Figure 3](#) and [Figure 4](#).

**Figure 3. APSR, IPSR and EPSR bit assignments**

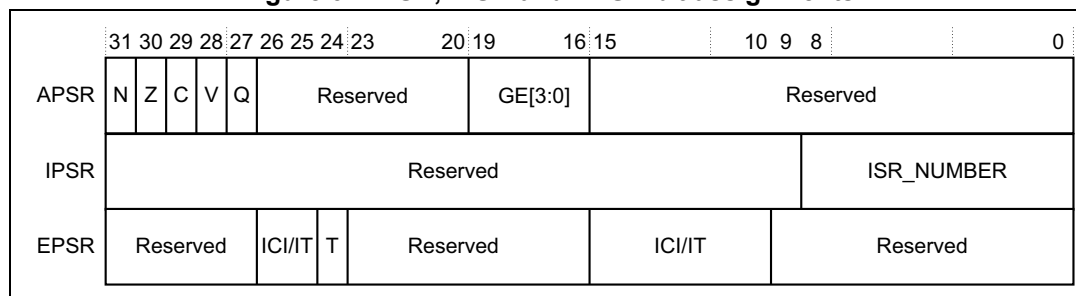

**Figure 4. PSR bit assignments**

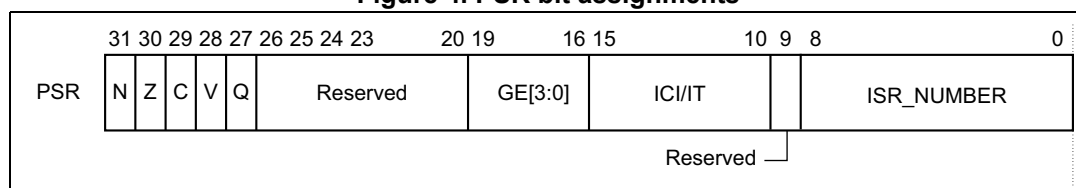

Access these registers individually or as a combination of any two or all three registers, using the register name as an argument to the MSR or MRS instructions. For example:

- Read all of the registers using PSR with the MRS instruction
- Write to the APSR N, Z, C, V, and Q bits using APSR\_nzcvq with the MSR instruction.

The PSR combinations and attributes are:

**Table 4. PSR register combinations**

Register	Type	Combination
PSR	read-write <sup>(1), (2)</sup>	APSR, EPSR, and IPSR
IEPSR	read-only	EPSR and IPSR
IAPSR	read-write <sup>(1)</sup>	APSR and IPSR
EAPSR	read-write <sup>(2)</sup>	APSR and EPSR

1. The processor ignores writes to the IPSR bits.
2. Reads of the EPSR bits return zero, and the processor ignores writes to the these bits

See the instruction descriptions [MRS on page 173](#) and [MSR on page 174](#) for more information about how to access the program status registers.

### Application program status register

The APSR contains the current state of the condition flags from previous instruction executions. See the register summary in [Table 3 on page 17](#) for its attributes. The bit assignments are:

**Table 5. APSR bit definitions**

Bits	Description
Bit 31	<b>N:</b> Negative or less than flag: 0: Operation result was positive, zero, greater than, or equal 1: Operation result was negative or less than.
Bit 30	<b>Z:</b> Zero flag: 0: Operation result was not zero 1: Operation result was zero.
Bit 29	<b>C:</b> Carry or borrow flag: 0: Add operation did not result in a carry bit or subtract operation resulted in a borrow bit 1: Add operation resulted in a carry bit or subtract operation did not result in a borrow bit.
Bit 28	<b>V:</b> Overflow flag: 0: Operation did not result in an overflow 1: Operation resulted in an overflow.
Bit 27	<b>Q:</b> DSP overflow and saturation flag: Sticky saturation flag. 0: Indicates that saturation has not occurred since reset or since the bit was last cleared to zero 1: Indicates when an SSAT or USAT instruction results in saturation, or indicates a DSP overflow. This bit is cleared to zero by software using an MRS instruction.
Bits 26:20	Reserved.
Bits 19:16	<b>GE[3:0]:</b> Greater than or Equal flags. See <a href="#">SEL on page 104</a> for more information.
Bits 15:0	Reserved.

### Interrupt program status register

The IPSR contains the exception type number of the current *Interrupt Service Routine* (ISR). See the register summary in [Table 3 on page 17](#) for its attributes. The bit assignments are:

**Table 6. IPSR bit definitions**

Bits	Description
Bits 31:9	Reserved
Bits 8:0	<p><b>ISR_NUMBER:</b>                      This is the number of the current exception:</p> <ul style="list-style-type: none"> <li>0: Thread mode</li> <li>1: Reserved</li> <li>2: NMI</li> <li>3: Hard fault</li> <li>4: Memory management fault</li> <li>5: Bus fault</li> <li>6: Usage fault</li> <li>7: Reserved</li> <li>....</li> <li>10: Reserved</li> <li>11: SVCall</li> <li>12: Reserved for Debug</li> <li>13: Reserved</li> <li>14: PendSV</li> <li>15: SysTick</li> <li>16: IRQ0<sup>(1)</sup></li> <li>....</li> <li>....</li> <li>83: IRQ81<sup>(1)</sup></li> </ul> <p>see <a href="#">Exception types on page 36</a> for more information.</p>

1. See STM32 product reference manual/datasheet for more information on interrupt mapping

### Execution program status register

The EPSR contains the Thumb state bit, and the execution state bits for either the:

- *If-Then* (IT) instruction
- *Interruptible-Continuable Instruction* (ICI) field for an interrupted load multiple or store multiple instruction.

See the register summary in [Table 3 on page 17](#) for the EPSR attributes. The bit assignments are:

Table 7. EPSR bit definitions

Bits	Description
Bits 31:27	Reserved.
Bits 26:25, 15:10	<b>ICI</b> : Interruptible-continuable instruction bits, see <a href="#">Interruptible-continuable instructions on page 22</a> .
Bits 26:25, 15:10	<b>IT</b> : Indicates the execution state bits of the IT instruction, see <a href="#">IT on page 144</a> .
Bit 24	T: Thumb state bit.
Bits 23:16	Reserved.
Bits 9:0	Reserved.

Attempts to read the EPSR directly through application software using the MSR instruction always return zero. Attempts to write the EPSR using the MSR instruction in application software are ignored. Fault handlers can examine EPSR value in the stacked PSR to indicate the operation that is at fault. See [Section 2.3.7: Exception entry and return on page 41](#).

### Interruptible-continuable instructions

When an interrupt occurs during the execution of an LDM STM, PUSH, POP, VLDM, VSTM, V PUSH, or VPOP instruction, the processor:

- Stops the load multiple or store multiple instruction operation temporarily
- Stores the next register operand in the multiple operation to EPSR bits[15:12].

After servicing the interrupt, the processor:

- Returns to the register pointed to by bits[15:12]
- Resumes execution of the multiple load or store instruction.

When the EPSR holds ICI execution state, bits[26:25,11:10] are zero.

### If-Then block

The If-Then block contains up to four instructions following a 16-bit IT instruction. Each instruction in the block is conditional. The conditions for the instructions are either all the same, or some can be the inverse of others. See [IT on page 144](#) for more information.

### Thumb state

The Cortex-M4 processor only supports execution of instructions in Thumb state. The following can clear the T bit to 0:

- Instructions BLX, BX and POP{PC}
- Restoration from the stacked xPSR value on an exception return
- Bit[0] of the vector value on an exception entry or reset

Attempting to execute instructions when the T bit is 0 results in a fault or lockup. See [Lockup on page 46](#) for more information.

### Exception mask registers

The exception mask registers disable the handling of exceptions by the processor. Disable exceptions where they might impact on timing critical tasks.

To access the exception mask registers use the MSR and MRS instructions, or the CPS instruction to change the value of PRIMASK or FAULTMASK. See [MRS on page 173](#), [MSR on page 174](#), and [CPS on page 171](#) for more information.

### Priority mask register

The PRIMASK register prevents activation of all exceptions with configurable priority. See the register summary in [Table 3 on page 17](#) for its attributes. [Figure 5](#) shows the bit assignments.

**Figure 5. PRIMASK bit assignments**

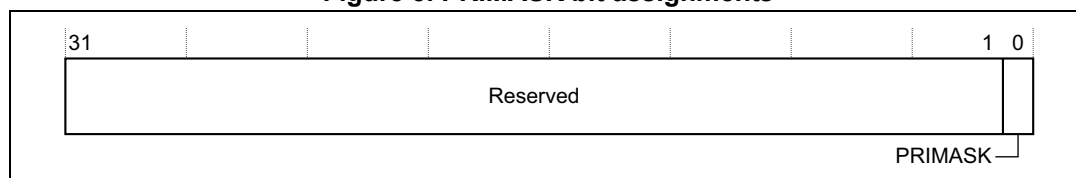

**Table 8. PRIMASK register bit definitions**

Bits	Description
Bits 31:1	Reserved
Bit 0	<b>PRIMASK:</b> 0: No effect 1: Prevents the activation of all exceptions with configurable priority.

### Fault mask register

The FAULTMASK register prevents activation of all exceptions except for *Non-Maskable Interrupt* (NMI). See the register summary in [Table 3 on page 17](#) for its attributes. [Figure 6](#) shows the bit assignments.

**Figure 6. FAULTMASK bit assignments**

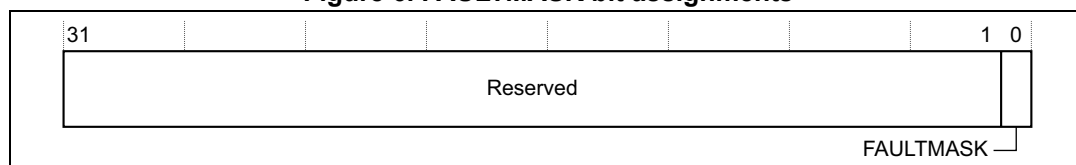

**Table 9. FAULTMASK register bit definitions**

Bits	Function
Bits 31:1	Reserved
Bit 0	<b>FAULTMASK:</b> 0: No effect 1: Prevents the activation of all exceptions except for NMI.

The processor clears the FAULTMASK bit to 0 on exit from any exception handler except the NMI handler.

### Base priority mask register

The BASEPRI register defines the minimum priority for exception processing. When BASEPRI is set to a nonzero value, it prevents the activation of all exceptions with same or lower priority level as the BASEPRI value. See the register summary in [Table 3 on page 17](#) for its attributes. [Figure 7](#) shows the bit assignments.

**Figure 7. BASEPRI bit assignments**

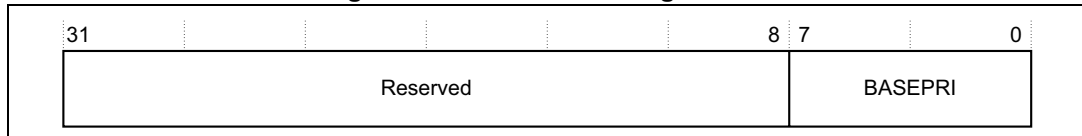

**Table 10. BASEPRI register bit assignments**

Bits	Function
Bits 31:8	Reserved
Bits 7:4	<b>BASEPRI[7:4]</b> Priority mask bits <sup>(1)</sup> 0x00: no effect Nonzero: defines the base priority for exception processing. The processor does not process any exception with a priority value greater than or equal to BASEPRI.
Bits 3:0	Reserved

1. This field is similar to the priority fields in the interrupt priority registers. See [Interrupt priority registers \(NVIC\\_IPRx\) on page 200](#) for more information. Remember that higher priority field values correspond to lower exception priorities.

### CONTROL register

The CONTROL register controls the stack used and the privilege level for software execution when the processor is in Thread mode and indicates whether the FPU state is active. See the register summary in [Table 3 on page 17](#) for its attributes.

**Table 11. CONTROL register bit definitions**

Bits	Function
Bits 31:3	Reserved
Bit 2	<b>FPCA:</b> Indicates whether floating-point context currently active: 0: No floating-point context active 1: Floating-point context active. The Cortex-M4 uses this bit to determine whether to preserve floating-point state when processing an exception.
Bit 1	<b>SPSEL:</b> Active stack pointer selection. Selects the current stack: 0: MSP is the current stack pointer 1: PSP is the current stack pointer. In Handler mode this bit reads as zero and ignores writes. The Cortex-M4 updates this bit automatically on exception return.
Bit 0	<b>nPRIV:</b> Thread mode privilege level. Defines the Thread mode privilege level. 0: Privileged 1: Unprivileged.



Handler mode always uses the MSP, so the processor ignores explicit writes to the active stack pointer bit of the CONTROL register when in Handler mode. The exception entry and return mechanisms update the CONTROL register.

In an OS environment, it is recommended that threads running in Thread mode use the process stack and the kernel and exception handlers use the main stack.

By default, Thread mode uses the MSP. To switch the stack pointer used in Thread mode to the PSP, either:

- use the MSR instruction to set the Active stack pointer bit to 1, see [MSR on page 174](#).
- perform an exception return to Thread mode with the appropriate EXC\_RETURN value, see [Exception return behavior on page 43](#).

When changing the stack pointer, software must use an ISB instruction immediately after the MSR instruction. This ensures that instructions after the ISB execute using the new stack pointer. See [ISB on page 173](#)

## 2.1.4 Exceptions and interrupts

The Cortex-M4 processor supports interrupts and system exceptions. The processor and the *Nested Vectored Interrupt Controller* (NVIC) prioritize and handle all exceptions. An exception changes the normal flow of software control. The processor uses handler mode to handle all exceptions except for reset. See [Exception entry on page 41](#) and [Exception return on page 43](#) for more information.

The NVIC registers control interrupt handling. See [Nested vectored interrupt controller \(NVIC\) on page 193](#) for more information.

## 2.1.5 Data types

The processor:

- Supports the following data types:
  - 32-bit words
  - 16-bit halfwords
  - 8-bit bytes
- manages all memory accesses as little-endian. See [Memory regions, types and attributes on page 28](#) for more information.

## 2.1.6 The Cortex microcontroller software interface standard (CMSIS)

For a Cortex-M4 microcontroller system, the *Cortex Microcontroller Software Interface Standard* (CMSIS) defines:

- A common way to:
  - Access peripheral registers
  - Define exception vectors
- The names of:
  - The registers of the core peripherals
  - The core exception vectors
- A device-independent interface for RTOS kernels, including a debug channel

The CMSIS includes address definitions and data structures for the core peripherals in the Cortex-M4 processor.

CMSIS simplifies software development by enabling the reuse of template code and the combination of CMSIS-compliant software components from various middleware vendors. Software vendors can expand the CMSIS to include their peripheral definitions and access functions for those peripherals.

This document includes the register names defined by the CMSIS, and gives short descriptions of the CMSIS functions that address the processor core and the core peripherals.

This document uses the register short names defined by the CMSIS. In a few cases these differ from the architectural short names that might be used in other documents.

The following sections give more information about the CMSIS:

- [Section 2.5.4: Power management programming hints on page 48](#)
- [CMSIS intrinsic functions on page 57](#)
- [Interrupt set-enable registers \(NVIC\\_ISERx\) on page 195](#)
- [NVIC programming hints on page 203](#)

## 2.2 Memory model

This section describes the processor memory map, the behavior of memory accesses, and the bit-banding features. The processor has a fixed memory map that provides up to 4 GB of addressable memory.

Figure 8. Memory map

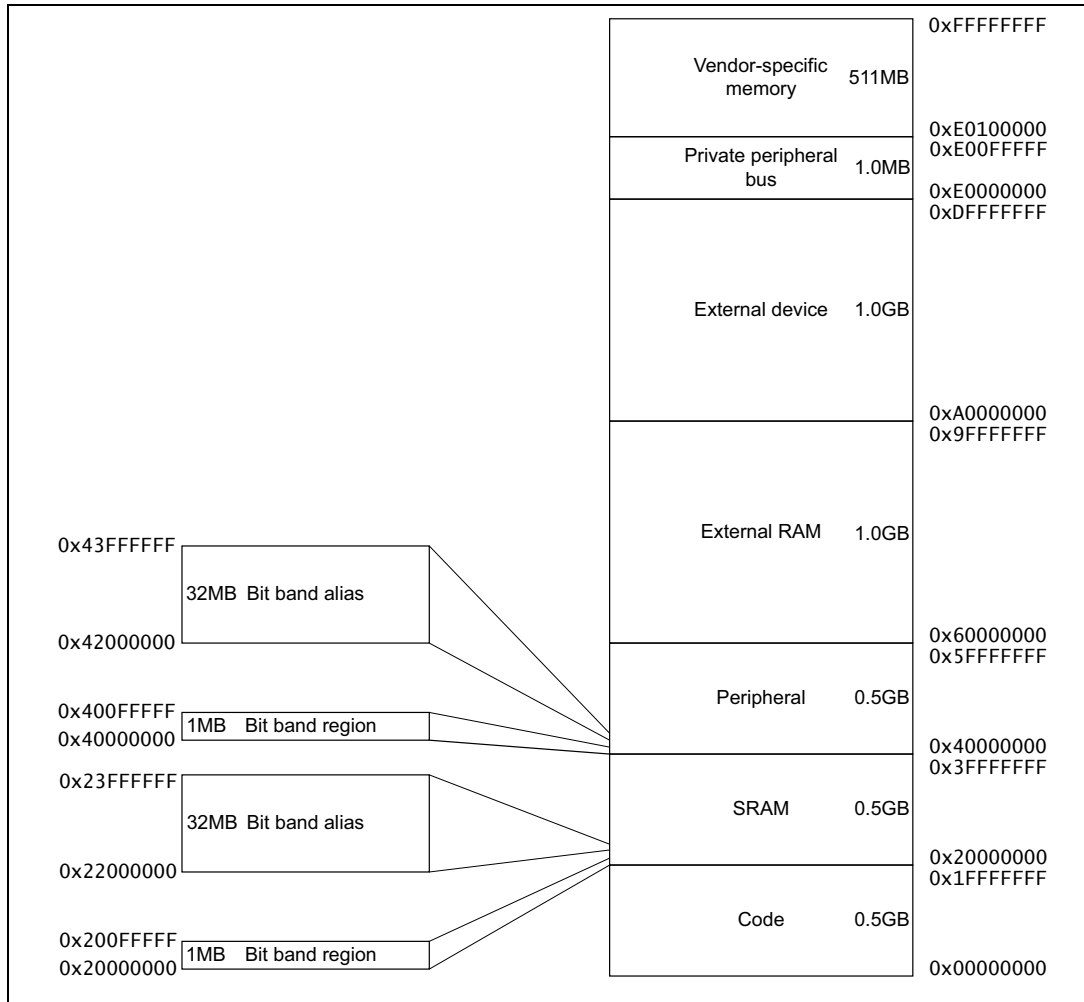

The regions for SRAM and peripherals include bit-banding regions. Bit-banding provides atomic operations to bit data, see [Section 2.2.5: Bit-banding on page 31](#).

The processor reserves regions of the *Private peripheral bus* (PPB) address range for core peripheral registers, see [Section 4.1: About the STM32 Cortex-M4 core peripherals on page 178](#).

### 2.2.1 Memory regions, types and attributes

The memory map and the programming of the MPU splits the memory map into regions. Each region has a defined memory type, and some regions have additional memory attributes. The memory type and attributes determine the behavior of accesses to the region.

The memory types are:

- Normal                      The processor can re-order transactions for efficiency, or perform speculative reads.
- Device                      The processor preserves transaction order relative to other transactions to Device or Strongly-ordered memory.
- Strongly-ordered             The processor preserves transaction order relative to all other transactions.

The different ordering requirements for Device and Strongly-ordered memory mean that the memory system can buffer a write to Device memory, but must not buffer a write to Strongly-ordered memory.

The additional memory attributes include:

- Execute Never (XN)*             Means the processor prevents instruction accesses. Any attempt to fetch an instruction from an XN region causes a memory management fault exception.

### 2.2.2 Memory system ordering of memory accesses

For most memory accesses caused by explicit memory access instructions, the memory system does not guarantee that the order in which the accesses complete matches the program order of the instructions, providing this does not affect the behavior of the instruction sequence. Normally, if correct program execution depends on two memory accesses completing in program order, software must insert a memory barrier instruction between the memory access instructions, see [Section 2.2.4: Software ordering of memory accesses on page 30](#).

However, the memory system does guarantee some ordering of accesses to Device and Strongly-ordered memory. For two memory access instructions A1 and A2, if A1 occurs before A2 in program order, the ordering of the memory accesses caused by two instructions is:

**Table 12. Ordering of memory accesses<sup>(1)</sup>**

A1	A2			Strongly ordered access
	Normal access	Device access		
		Non-shareable	Shareable	
Normal access	-	-	-	-
Device access, non-shareable	-	<	-	<
Device access, shareable	-	-	<	<
Strongly ordered access	-	<	<	<

1. - means that the memory system does not guarantee the ordering of the accesses.  
 < means that accesses are observed in program order, that is, A1 is always observed before A2.



### 2.2.3 Behavior of memory accesses

The behavior of accesses to each region in the memory map is:

**Table 13. Memory access behavior**

Address range	Memory region	Memory type	XN	Description
0x00000000-0x1FFFFFFF	Code	Normal <sup>(1)</sup>	-	Executable region for program code. Can also put data here.
0x20000000-0x3FFFFFFF	SRAM	Normal <sup>(1)</sup>	-	Executable region for data. Can also put code here. This region includes bit band and bit band alias areas, see <a href="#">Table 14 on page 31</a> .
0x40000000-0x5FFFFFFF	Peripheral	Device <sup>(1)</sup>	XN <sup>(1)</sup>	This region includes bit band and bit band alias areas, see <a href="#">Table 15 on page 31</a> .
0x60000000-0x9FFFFFFF	External RAM	Normal <sup>(1)</sup>	-	Executable region for data.
0xA0000000-0xDFFFFFFF	External device	Device <sup>(1)</sup>	XN <sup>(1)</sup>	External Device memory
0xED000000-0xED0FFFFF	Private Peripheral Bus	Strongly-ordered <sup>(1)</sup>	XN <sup>(1)</sup>	This region includes the NVIC, System timer, and system control block.
0xED100000-0xFFFFFFFF	Memory mapped peripherals	Device <sup>(1)</sup>	XN <sup>(1)</sup>	This region includes all the STM32 standard peripherals.

1. See [Memory regions, types and attributes on page 28](#) for more information.

The Code, SRAM, and external RAM regions can hold programs. However, it is recommended that programs always use the Code region. This is because the processor has separate buses that enable instruction fetches and data accesses to occur simultaneously.

The MPU can override the default memory access behavior described in this section. For more information, see [Memory protection unit \(MPU\) on page 178](#).

#### Instruction prefetch and branch prediction

The Cortex-M4 processor:

- Prefetches instructions ahead of execution
- Speculatively prefetches from branch target addresses.

## 2.2.4 Software ordering of memory accesses

The order of instructions in the program flow does not always guarantee the order of the corresponding memory transactions. This is because:

- The processor can reorder some memory accesses to improve efficiency, providing this does not affect the behavior of the instruction sequence.
- The processor has multiple bus interfaces
- Memory or devices in the memory map have different wait states
- Some memory accesses are buffered or speculative.

[Section 2.2.2: Memory system ordering of memory accesses on page 28](#) describes the cases where the memory system guarantees the order of memory accesses. Otherwise, if the order of memory accesses is critical, software must include memory barrier instructions to force that ordering. The processor provides the following memory barrier instructions:

**DMB** The *Data Memory Barrier* (DMB) instruction ensures that outstanding memory transactions complete before subsequent memory transactions. See [DMB on page 172](#).

**DSB** The *Data Synchronization Barrier* (DSB) instruction ensures that outstanding memory transactions complete before subsequent instructions execute. See [DSB on page 172](#).

**ISB** The *Instruction Synchronization Barrier* (ISB) ensures that the effect of all completed memory transactions is recognizable by subsequent instructions. See [ISB on page 173](#).

Use memory barrier instructions in, for example:

- **Vector table.** If the program changes an entry in the vector table, and then enables the corresponding exception, use a DMB instruction between the operations. This ensures that if the exception is taken immediately after being enabled the processor uses the new exception vector.
- **Self-modifying code.** If a program contains self-modifying code, use an ISB instruction immediately after the code modification in the program. This ensures subsequent instruction execution uses the updated program.
- **Memory map switching.** If the system contains a memory map switching mechanism, use a DSB instruction after switching the memory map in the program. This ensures subsequent instruction execution uses the updated memory map.
- **Dynamic exception priority change.** When an exception priority has to change when the exception is pending or active, use DSB instructions after the change. This ensures the change takes effect on completion of the DSB instruction.
- **Using a semaphore in multi-master system.** If the system contains more than one bus master, for example, if another processor is present in the system, each processor must use a DMB instruction after any semaphore instructions, to ensure other bus masters see the memory transactions in the order in which they were executed.

Memory accesses to Strongly-ordered memory, such as the system control block, do not require the use of DMB instructions.

For MPU programming, use a DSB followed by an ISB instruction or exception return to ensure that the new MPU configuration is used by subsequent instructions.

## 2.2.5 Bit-banding

A bit-band region maps each word in a *bit-band alias* region to a single bit in the *bit-band region*. The bit-band regions occupy the lowest 1 MB of the SRAM and peripheral memory regions.

The memory map has two 32 MB alias regions that map to two 1 MB bit-band regions:

- Accesses to the 32 MB SRAM alias region map to the 1 MB SRAM bit-band region, as shown in [Table 14](#)
- Accesses to the 32 MB peripheral alias region map to the 1 MB peripheral bit-band region, as shown in [Table 15](#).

**Table 14. SRAM memory bit-banding regions**

Address range	Memory region	Instruction and data accesses
0x20000000-0x200FFFFFF	SRAM bit-band region	Direct accesses to this memory range behave as SRAM memory accesses, but this region is also bit addressable through bit-band alias.
0x22000000-0x23FFFFFFF	SRAM bit-band alias	Data accesses to this region are remapped to bit band region. A write operation is performed as read-modify-write. Instruction accesses are not remapped.

**Table 15. Peripheral memory bit-banding regions**

Address range	Memory region	Instruction and data accesses
0x40000000-0x400FFFFFF	Peripheral bit-band region	Direct accesses to this memory range behave as peripheral memory accesses, but this region is also bit addressable through bit-band alias.
0x42000000-0x43FFFFFFF	Peripheral bit-band alias	Data accesses to this region are remapped to bit-band region. A write operation is performed as read-modify-write. Instruction accesses are not permitted.

*Note:* A word access to the SRAM or peripheral bit-band alias regions map to a single bit in the SRAM or peripheral bit-band region.

*Bit band accesses can use byte, halfword, or word transfers. The bit band transfer size matches the transfer size of the instruction making the bit band access.*

The following formula shows how the alias region maps onto the bit-band region:

$$\text{bit\_word\_offset} = (\text{byte\_offset} \times 32) + (\text{bit\_number} \times 4)$$

$$\text{bit\_word\_addr} = \text{bit\_band\_base} + \text{bit\_word\_offset}$$

Where:

- Bit\_word\_offset is the position of the target bit in the bit-band memory region.
- Bit\_word\_addr is the address of the word in the alias memory region that maps to the targeted bit.
- Bit\_band\_base is the starting address of the alias region.
- Byte\_offset is the number of the byte in the bit-band region that contains the targeted bit.
- Bit\_number is the bit position, 0-7, of the targeted bit.

Figure 9 on page 32 shows examples of bit-band mapping between the SRAM bit-band alias region and the SRAM bit-band region:

- The alias word at 0x23FFFFFFED maps to bit[0] of the bit-band byte at 0x200FFFFFF:  $0x23FFFFFFED = 0x22000000 + (0xFFFF*32) + (0*4)$ .
- The alias word at 0x23FFFFFFC maps to bit[7] of the bit-band byte at 0x200FFFFFF:  $0x23FFFFFFC = 0x22000000 + (0xFFFF*32) + (7*4)$ .
- The alias word at 0x22000000 maps to bit[0] of the bit-band byte at 0x20000000:  $0x22000000 = 0x22000000 + (0*32) + (0*4)$ .
- The alias word at 0x2200001C maps to bit[7] of the bit-band byte at 0x20000000:  $0x2200001C = 0x22000000 + (0*32) + (7*4)$ .

Figure 9. Bit-band mapping

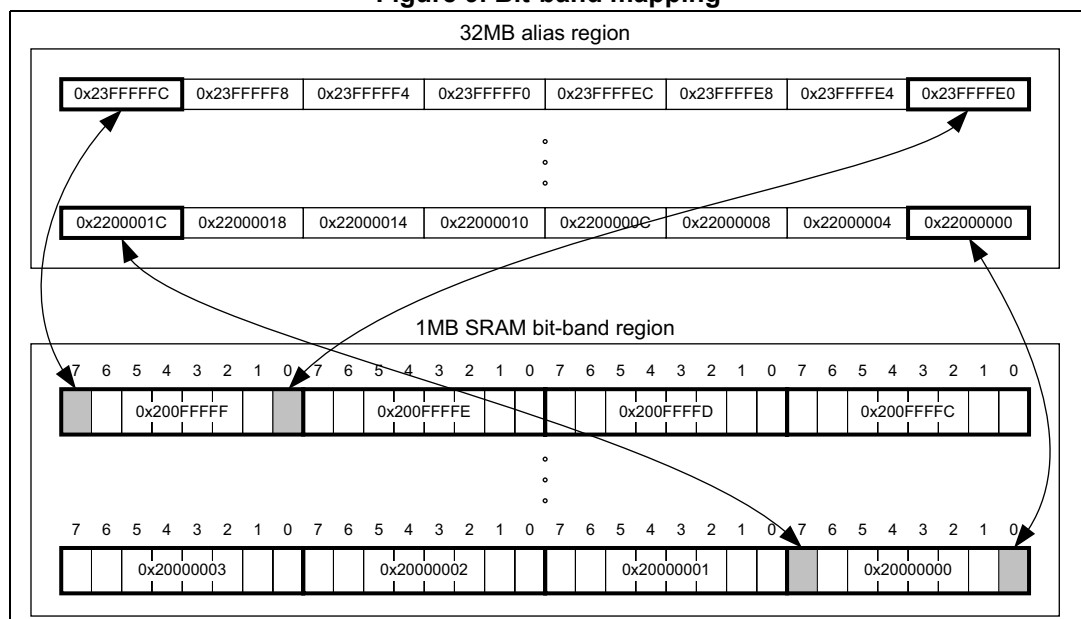

Directly accessing an alias region

Writing to a word in the alias region updates a single bit in the bit-band region.

Bit[0] of the value written to a word in the alias region determines the value written to the targeted bit in the bit-band region. Writing a value with bit[0] set to 1 writes a 1 to the bit-band bit, and writing a value with bit[0] set to 0 writes a 0 to the bit-band bit.

Bits[31:1] of the alias word have no effect on the bit-band bit. Writing 0x01 has the same effect as writing 0xFF. Writing 0x00 has the same effect as writing 0x0E.



Reading a word in the alias region:

- 0x00000000 indicates that the targeted bit in the bit-band region is set to zero
- 0x00000001 indicates that the targeted bit in the bit-band region is set to 1

Directly accessing a bit-band region

[Behavior of memory accesses on page 29](#) describes the behavior of direct byte, halfword, or word accesses to the bit-band regions.

## 2.2.6 Memory endianness

The processor views memory as a linear collection of bytes numbered in ascending order from zero. For example, bytes 0-3 hold the first stored word, and bytes 4-7 hold the second stored word.

### Little-endian format

In little-endian format, the processor stores the least significant byte of a word at the lowest-numbered byte, and the most significant byte at the highest-numbered byte. See [Figure 10](#) for an example.

Figure 10. Little-endian example

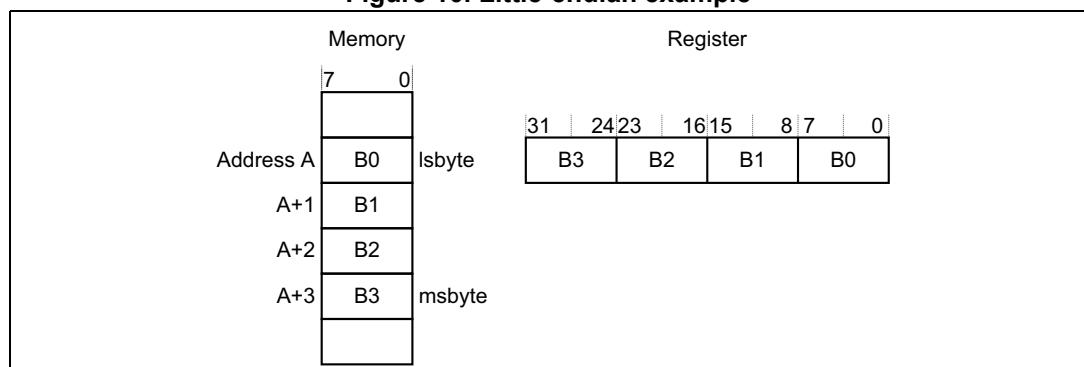

## 2.2.7 Synchronization primitives

The Cortex-M4 instruction set includes pairs of *synchronization primitives*. These provide a non-blocking mechanism that a thread or process can use to obtain exclusive access to a memory location. Software can use them to perform a guaranteed read-modify-write memory update sequence, or for a semaphore mechanism.

A pair of synchronization primitives comprises:

- A Load-Exclusive instruction: Used to read the value of a memory location, requesting exclusive access to that location.
- A Store-Exclusive instruction: Used to attempt to write to the same memory location, returning a status bit to a register. If this bit is:
  - 0: the thread or process gained exclusive access to memory, and the write succeeds
  - 1: the thread or process did not gain exclusive access to memory, and no write is performed.

The pairs of Load-Exclusive and Store-Exclusive instructions are:

- The word instructions LDREX and STREX
- The halfword instructions LDREXH and STREXH
- The byte instructions LDREXB and STREXB.

Software must use a Load-Exclusive instruction with the corresponding Store-Exclusive instruction.

To perform a guaranteed read-modify-write of a memory location, software must:

1. Use a Load-Exclusive instruction to read the value of the location.
2. Update the value, as required.
3. Use a Store-Exclusive instruction to attempt to write the new value back to the memory location.
4. Test the returned status bit. If this bit is:
  - 0: The read-modify-write completed successfully,
  - 1: No write was performed. This indicates that the value returned at step 1 might be out of date. The software must retry the read-modify-write sequence,

Software can use the synchronization primitives to implement a semaphores as follows:

1. Use a Load-Exclusive instruction to read from the semaphore address to check whether the semaphore is free.
2. If the semaphore is free, use a Store-Exclusive to write the claim value to the semaphore address.
3. If the returned status bit from step 2 indicates that the Store-Exclusive succeeded then the software has claimed the semaphore. However, if the Store-Exclusive failed, another process might have claimed the semaphore after software performed step 1.

The Cortex-M4 includes an exclusive access monitor, that tags the fact that the processor has executed a Load-Exclusive instruction. If the processor is part of a multiprocessor system, the system also globally tags the memory locations addressed by exclusive accesses by each processor.

The processor removes its exclusive access tag if:

- It executes a CLREX instruction
- It executes a Store-Exclusive instruction, regardless of whether the write succeeds.
- An exception occurs. This means the processor can resolve semaphore conflicts between different threads.

In a multiprocessor implementation, executing a:

- CLREX instruction removes only the local exclusive access tag for the processor
- Store-Exclusive instruction, or an exception. removes the local exclusive access tags, and global exclusive access tags for the processor.

For more information about the synchronization primitive instructions, see [LDREX and STREX on page 78](#) and [CLREX on page 79](#).

## 2.2.8 Programming hints for the synchronization primitives

ISO/IEC C cannot directly generate the exclusive access instructions. CMSIS provides intrinsic functions for generation of these instructions:

**Table 16. CMSIS functions for exclusive access instructions**

Instruction	CMSIS function
LDREX	uint32_t __LDREXW (uint32_t *addr)
LDREXH	uint16_t __LDREXH (uint16_t *addr)
LDREXB	uint8_t __LDREXB (uint8_t *addr)
STREX	uint32_t __STREXW (uint32_t value, uint32_t *addr)
STREXH	uint32_t __STREXH (uint16_t value, uint16_t *addr)
STREXB	uint32_t __STREXB (uint8_t value, uint8_t *addr)
CLREX	void __CLREX (void)

For example:

```
uint16_t value;
uint16_t *address = 0x20001002;
value = __LDREXH (address); // load 16-bit value from memory address
                             //0x20001002
```

## 2.3 Exception model

This section describes the exception model.

### 2.3.1 Exception states

Each exception is in one of the following states:

Inactive	The exception is not active and not pending.
Pending	The exception is waiting to be serviced by the processor. An interrupt request from a peripheral or from software can change the state of the corresponding interrupt to pending.
Active	An exception that is being serviced by the processor but has not completed. <i>Note: An exception handler can interrupt the execution of another exception handler. In this case both exceptions are in the active state.</i>
Active and pending	The exception is being serviced by the processor and there is a pending exception from the same source.

### 2.3.2 Exception types

The exception types are:

Reset	Reset is invoked on power up or a warm reset. The exception model treats reset as a special form of exception. When reset is asserted, the operation of the processor stops, potentially at any point in an instruction. When reset is deasserted, execution restarts from the address provided by the reset entry in the vector table. Execution restarts as privileged execution in Thread mode.
NMI	A <i>NonMaskable Interrupt</i> (NMI) can be signalled by a peripheral or triggered by software. This is the highest priority exception other than reset. It is permanently enabled and has a fixed priority of -2. NMIs cannot be: <ul style="list-style-type: none"> <li>Masked or prevented from activation by any other exception</li> <li>Preempted by any exception other than Reset.</li> </ul>
Hard fault	A hard fault is an exception that occurs because of an error during exception processing, or because an exception cannot be managed by any other exception mechanism. Hard faults have a fixed priority of -1, meaning they have higher priority than any exception with configurable priority.
Memory management fault	A memory management fault is an exception that occurs because of a memory protection related fault. The MPU or the fixed memory protection constraints determines this fault, for both instruction and data memory transactions. This fault is used to abort instruction accesses to <i>Execute Never</i> (XN) memory regions.

Bus fault	A bus fault is an exception that occurs because of a memory related fault for an instruction or data memory transaction. This might be from an error detected on a bus in the memory system.
Usage fault	<p>A usage fault is an exception that occurs because of a fault related to instruction execution. This includes:</p> <ul style="list-style-type: none"> <li>• An undefined instruction</li> <li>• An illegal unaligned access</li> <li>• Invalid state on instruction execution</li> <li>• An error on exception return.</li> </ul> <p>The following can cause a usage fault when the core is configured to report them:</p> <ul style="list-style-type: none"> <li>• An unaligned address on word and halfword memory access</li> <li>• Division by zero</li> </ul>
SVCall	A <i>supervisor call</i> (SVC) is an exception that is triggered by the SVC instruction. In an OS environment, applications can use SVC instructions to access OS kernel functions and device drivers.
PendSV	PendSV is an interrupt-driven request for system-level service. In an OS environment, use PendSV for context switching when no other exception is active.
SysTick	A SysTick exception is an exception the system timer generates when it reaches zero. Software can also generate a SysTick exception. In an OS environment, the processor can use this exception as system tick.
Interrupt (IRQ)	A interrupt, or IRQ, is an exception signalled by a peripheral, or generated by a software request. All interrupts are asynchronous to instruction execution. In the system, peripherals use interrupts to communicate with the processor.

**Table 17. Properties of the different exception types**

Exception number <sup>(1)</sup>	IRQ number <sup>(1)</sup>	Exception type	Priority	Vector address or offset <sup>(2)</sup>	Activation
1	-	Reset	-3, the highest	0x00000004	Asynchronous
2	-14	NMI	-2	0x00000008	Asynchronous
3	-13	Hard fault	-1	0x0000000C	-
4	-12	Memory management fault	Configurable <sup>(3)</sup>	0x00000010	Synchronous
5	-11	Bus fault	Configurable <sup>(3)</sup>	0x00000014	Synchronous when precise Asynchronous when imprecise
6	-10	Usage fault	Configurable <sup>(3)</sup>	0x00000018	Synchronous
7-10	-	-	-	Reserved	-
11	-5	SVCall	Configurable <sup>(3)</sup>	0x0000002C	Synchronous
12-13	-	-	-	Reserved	-
14	-2	PendSV	Configurable <sup>(3)</sup>	0x00000038	Asynchronous

**Table 17. Properties of the different exception types (continued)**

Exception number <sup>(1)</sup>	IRQ number <sup>(1)</sup>	Exception type	Priority	Vector address or offset <sup>(2)</sup>	Activation
15	-1	SysTick	Configurable <sup>(3)</sup>	0x0000003C	Asynchronous
16 and above	0 and above	Interrupt (IRQ)	Configurable <sup>(4)</sup>	0x00000040 and above <sup>(5)</sup>	Asynchronous

1. To simplify the software layer, the CMSIS only uses IRQ numbers and therefore uses negative values for exceptions other than interrupts. The IPSR returns the Exception number, see [Interrupt program status register on page 21](#).
2. See [Vector table on page 39](#) for more information.
3. See [System handler priority registers \(SHPRx\) on page 217](#).
4. See [Interrupt priority registers \(NVIC\\_IPRx\) on page 200](#).
5. Increasing in steps of 4.

For an asynchronous exception other than reset, the processor can execute another instruction between when the exception is triggered and when the processor enters the exception handler.

Privileged software can disable the exceptions that [Table 17 on page 37](#) shows as having configurable priority, see:

- [System handler control and state register \(SHCSR\) on page 219](#)
- [Interrupt clear-enable registers \(NVIC\\_ICERx\) on page 196](#)

For more information about hard faults, memory management faults, bus faults, and usage faults, see [Section 2.4: Fault handling on page 43](#).

### 2.3.3 Exception handlers

The processor handles exceptions using:

Interrupt Service Routines (ISRs)	Interrupts IRQ0 to IRQ81 are the exceptions handled by ISRs.
Fault handlers	Hard fault, memory management fault, usage fault, bus fault are fault exceptions handled by the fault handlers.
System handlers	NMI, PendSV, SVCall SysTick, and the fault exceptions are all system exceptions that are handled by system handlers.

### 2.3.4 Vector table

The vector table contains the reset value of the stack pointer, and the start addresses, also called exception vectors, for all exception handlers. [Figure 11 on page 39](#) shows the order of the exception vectors in the vector table. The least-significant bit of each vector must be 1, indicating that the exception handler is Thumb code.

**Figure 11. Vector table**

Exception number	IRQ number	Offset	Vector
255	239	0x03FC	IRQ239
.	.	.	.
.	.	.	.
18	2	0x004C	IRQ2
17	1	0x0048	IRQ1
16	0	0x0044	IRQ0
15	-1	0x0040	Systick
14	-2	0x003C	PendSV
13		0x0038	Reserved
12			Reserved for Debug
11	-5	0x002C	SVCall
10			Reserved
9			
8			
7			
6	-10	0x0018	Usage fault
5	-11	0x0014	Bus fault
4	-12	0x0010	Memory management fault
3	-13	0x000C	Hard fault
2	-14	0x0008	NMI
1		0x0004	Reset
		0x0000	Initial SP value

MS30018V1

On system reset, the vector table is fixed at address 0x00000000. Privileged software can write to the VTOR to relocate the vector table start address to a different memory location, in the range 0x00000080 to 0x3FFFFFF80, see [Vector table offset register \(VTOR\) on page 212](#).

### 2.3.5 Exception priorities

As [Table 17 on page 37](#) shows, all exceptions have an associated priority, with:

- A lower priority value indicating a higher priority
- Configurable priorities for all exceptions except Reset, Hard fault, and NMI.

If software does not configure any priorities, then all exceptions with a configurable priority have a priority of 0. For information about configuring exception priorities see

- [System handler priority registers \(SHPRx\) on page 217](#)
- [Interrupt priority registers \(NVIC\\_IPRx\) on page 200](#)

Configurable priority values are in the range 0-15. This means that the Reset, Hard fault, and NMI exceptions, with fixed negative priority values, always have higher priority than any other exception.

For example, assigning a higher priority value to IRQ[0] and a lower priority value to IRQ[1] means that IRQ[1] has higher priority than IRQ[0]. If both IRQ[1] and IRQ[0] are asserted, IRQ[1] is processed before IRQ[0].

If multiple pending exceptions have the same priority, the pending exception with the lowest exception number takes precedence. For example, if both IRQ[0] and IRQ[1] are pending and have the same priority, then IRQ[0] is processed before IRQ[1].

When the processor is executing an exception handler, the exception handler is preempted if a higher priority exception occurs. If an exception occurs with the same priority as the exception being handled, the handler is not preempted, irrespective of the exception number. However, the status of the new interrupt changes to pending.

### 2.3.6 Interrupt priority grouping

To increase priority control in systems with interrupts, the NVIC supports priority grouping. This divides each interrupt priority register entry into two fields:

- An upper field that defines the *group priority*
- A lower field that defines a *subpriority* within the group.

Only the group priority determines preemption of interrupt exceptions. When the processor is executing an interrupt exception handler, another interrupt with the same group priority as the interrupt being handled does not preempt the handler,

If multiple pending interrupts have the same group priority, the subpriority field determines the order in which they are processed. If multiple pending interrupts have the same group priority and subpriority, the interrupt with the lowest IRQ number is processed first.

For information about splitting the interrupt priority fields into group priority and subpriority, see [Application interrupt and reset control register \(AIRCR\) on page 212](#).



### 2.3.7 Exception entry and return

Descriptions of exception handling use the following terms:

**Preemption** When the processor is executing an exception handler, an exception can preempt the exception handler if its priority is higher than the priority of the exception being handled. See [Section 2.3.6: Interrupt priority grouping](#) for more information about preemption by an interrupt.

When one exception preempts another, the exceptions are called nested exceptions. See [Exception entry on page 41](#) more information.

**Return** This occurs when the exception handler is completed, and:

- There is no pending exception with sufficient priority to be serviced
- The completed exception handler was not handling a late-arriving exception.

The processor pops the stack and restores the processor state to the state it had before the interrupt occurred. See [Exception return on page 43](#) for more information.

**Tail-chaining** This mechanism speeds up exception servicing. On completion of an exception handler, if there is a pending exception that meets the requirements for exception entry, the stack pop is skipped and control transfers to the new exception handler.

**Late-arriving** This mechanism speeds up preemption. If a higher priority exception occurs during state saving for a previous exception, the processor switches to handle the higher priority exception and initiates the vector fetch for that exception. State saving is not affected by late arrival because the state saved is the same for both exceptions. Therefore the state saving continues uninterrupted. The processor can accept a late arriving exception until the first instruction of the exception handler of the original exception enters the execute stage of the processor. On return from the exception handler of the late-arriving exception, the normal tail-chaining rules apply.

#### Exception entry

Exception entry occurs when there is a pending exception with sufficient priority and either:

- The processor is in Thread mode
- The new exception is of higher priority than the exception being handled, in which case the new exception preempts the original exception.

When one exception preempts another, the exceptions are nested.

Sufficient priority means the exception has more priority than any limits set by the mask registers, see [Exception mask registers on page 22](#). An exception with less priority than this is pending but is not handled by the processor.

When the processor takes an exception, unless the exception is a tail-chained or a late-arriving exception, the processor pushes information onto the current stack. This operation is referred as *stacking* and the structure of eight data words is referred as *stack frame*.

When using floating-point routines, the Cortex-M4 processor automatically stacks the architected floating-point state on exception entry. [Figure 12 on page 42](#) shows the Cortex-M4 stack frame layout when floating-point state is preserved on the stack as the result of an interrupt or an exception. Where stack space for floating-point state is not allocated, the

stack frame is the same as that of ARMv7-M implementations without an FPU. [Figure 12 on page 42](#) shows this stack frame also.

**Figure 12. Cortex-M4 stack frame layout**

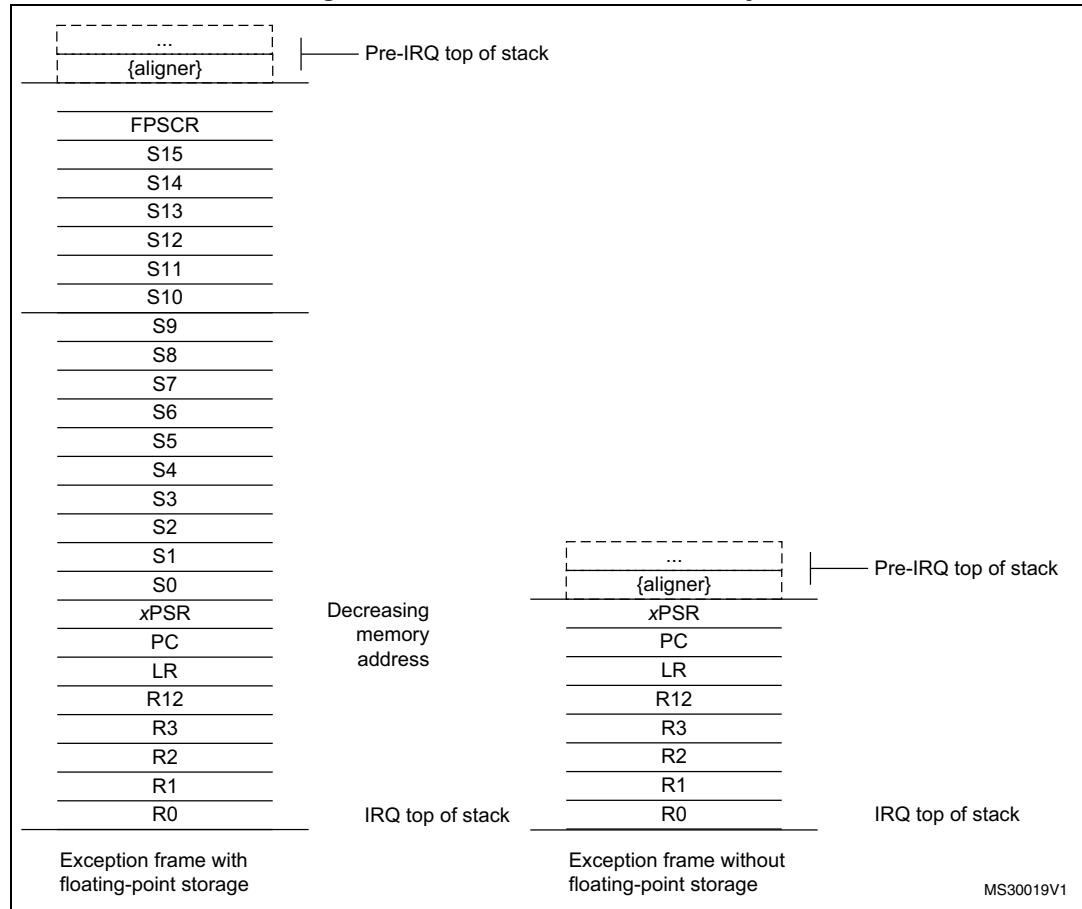

Immediately after stacking, the stack pointer indicates the lowest address in the stack frame. The alignment of the stack frame is controlled via the STKALIGN bit of the Configuration Control Register (CCR).

The stack frame includes the return address. This is the address of the next instruction in the interrupted program. This value is restored to the PC at exception return so that the interrupted program resumes.

In parallel to the stacking operation, the processor performs a vector fetch that reads the exception handler start address from the vector table. When stacking is complete, the processor starts executing the exception handler. At the same time, the processor writes an EXC\_RETURN value to the LR. This indicates which stack pointer corresponds to the stack frame and what operation mode the processor was in before the entry occurred.

If no higher priority exception occurs during exception entry, the processor starts executing the exception handler and automatically changes the status of the corresponding pending interrupt to active.

If another higher priority exception occurs during exception entry, the processor starts executing the exception handler for this exception and does not change the pending status of the earlier exception. This is the late arrival case.

## Exception return

Exception return occurs when the processor is in Handler mode and executes one of the following instructions to load the EXC\_RETURN value into the PC:

- an LDM or POP instruction that loads the PC
- an LDR instruction with PC as the destination
- a BX instruction using any register.

EXC\_RETURN is the value loaded into the LR on exception entry. The exception mechanism relies on this value to detect when the processor has completed an exception handler. The lowest five bits of this value provide information on the return stack and processor mode. [Table 18](#) shows the EXC\_RETURN values with a description of the exception return behavior.

All EXC\_RETURN values have bits[31:5] set to one. When this value is loaded into the PC it indicates to the processor that the exception is complete, and the processor initiates the appropriate exception return sequence.

**Table 18. Exception return behavior**

EXC_RETURN[31:0]	Description
0xFFFFFFFF1	Return to Handler mode, exception return uses non-floating-point state from the MSP and execution uses MSP after return.
0xFFFFFFFF9	Return to Thread mode, exception return uses non-floating-point state from MSP and execution uses MSP after return.
0xFFFFFFFFD	Return to Thread mode, exception return uses non-floating-point state from the PSP and execution uses PSP after return.
0xFFFFFEE1	Return to Handler mode, exception return uses floating-point-state from MSP and execution uses MSP after return.
0xFFFFFEE9	Return to Thread mode, exception return uses floating-point state from MSP and execution uses MSP after return.
0xFFFFFEEF	Return to Thread mode, exception return uses floating-point state from PSP and execution uses PSP after return.

## 2.4 Fault handling

Faults are a subset of the exceptions, see [Exception model on page 36](#). The following generate a fault:

- A bus error on:
  - An instruction fetch or vector table load
  - A data access
- An internally-detected error such as an undefined instruction
- Attempting to execute an instruction from a memory region marked as *Non-Executable* (XN).
- A privilege violation or an attempt to access an unmanaged region causing an MPU fault.

### 2.4.1 Fault types

Table 19 shows the types of fault, the handler used for the fault, the corresponding fault status register, and the register bit that indicates that the fault has occurred. See [Configurable fault status register \(CFSR; UFSR+BFSR+MMFSR\) on page 221](#) for more information about the fault status registers.

**Table 19. Faults**

Fault	Handler	Bit name	Fault status register
Bus error on a vector read	Hard fault	VECTTBL	<a href="#">Hard fault status register (HFSR) on page 225</a>
Fault escalated to a hard fault		FORCED	
MPU or default memory map mismatch:	MemManage	-	<a href="#">Memory management fault address register (MMFAR) on page 226</a>
– on instruction access		IACCVIOL <sup>(1)</sup>	
– on data access		DACCVIOL	
– during exception stacking		MSTKERR	
– during exception unstacking		MUNSKERR	
– during lazy floating-point state preservation	MLSPERR		
Bus error:	Bus fault	-	<a href="#">Bus fault address register (BFAR) on page 226</a>
– During exception stacking		STKERR	
– During exception unstacking		UNSTKERR	
– During instruction prefetch		IBUSERR	
– During lazy floating-point state preservation		LSPERR	
Precise data bus error		PRECISERR	
Imprecise data bus error		IMPRECISERR	
Attempt to access a coprocessor	Usage fault	NOCP	<a href="#">Configurable fault status register (CFSR; UFSR+BFSR+MMFSR) on page 221</a>
Undefined instruction		UNDEFINSTR	
Attempt to enter an invalid instruction set state <sup>(2)</sup>		INVSTATE	
Invalid EXC_RETURN value		INVPC	
Illegal unaligned load or store		UNALIGNED	
Divide By 0		DIVBYZERO	

1. Occurs on an access to an XN region even if the MPU is disabled.
2. Attempting to use an instruction set other than the Thumb instruction set, or returns to a non load/store-multiple instruction with ICI continuation.

## 2.4.2 Fault escalation and hard faults

All faults exceptions except for hard fault have configurable exception priority, see [System handler priority registers \(SHPRx\) on page 217](#). Software can disable execution of the handlers for these faults, see [System handler control and state register \(SHCSR\) on page 219](#).

Usually, the exception priority, together with the values of the exception mask registers, determines whether the processor enters the fault handler, and whether a fault handler can preempt another fault handler. as described in [Section 2.3: Exception model on page 36](#).

In some situations, a fault with configurable priority is treated as a hard fault. This is called *priority escalation*, and the fault is described as *escalated to hard fault*. Escalation to hard fault occurs when:

- A fault handler causes the same kind of fault as the one it is servicing. This escalation to hard fault occurs because a fault handler cannot preempt itself because it must have the same priority as the current priority level.
- A fault handler causes a fault with the same or lower priority as the fault it is servicing. This is because the handler for the new fault cannot preempt the currently executing fault handler.
- An exception handler causes a fault for which the priority is the same as or lower than the currently executing exception.
- A fault occurs and the handler for that fault is not enabled.

If a bus fault occurs during a stack push when entering a bus fault handler, the bus fault does not escalate to a hard fault. This means that if a corrupted stack causes a fault, the fault handler executes even though the stack push for the handler failed. The fault handler operates but the stack contents are corrupted.

Only Reset and NMI can preempt the fixed priority hard fault. A hard fault can preempt any exception other than Reset, NMI, or another hard fault.

### 2.4.3 Fault status registers and fault address registers

The fault status registers indicate the cause of a fault. For bus faults and memory management faults, the fault address register indicates the address accessed by the operation that caused the fault, as shown in [Table 20](#).

**Table 20. Fault status and fault address registers**

Handler	Status register name	Address register name	Register description
Hard fault	HFSR	-	<a href="#">Hard fault status register (HFSR) on page 225</a>
Memory management fault	MMFSR	MMFAR	<a href="#">Memory management fault address register (MMFAR) on page 226</a>
Bus fault	BFSR	BFAR	<a href="#">Bus fault address register (BFAR) on page 226</a>
Usage fault	UFSR	-	<a href="#">Configurable fault status register (CFSR; UFSR+BFAR+MMFSR) on page 221</a>

### 2.4.4 Lockup

The processor enters a lockup state if a hard fault occurs when executing the NMI or hard fault handlers. When the processor is in lockup state it does not execute any instructions. The processor remains in lockup state until either:

- It is reset
- An NMI occurs
- It is halted by a debugger.

If lockup state occurs from the NMI handler a subsequent NMI does not cause the processor to leave lockup state.

## 2.5 Power management

The STM32 and Cortex-M4 processor sleep modes reduce power consumption:

- Sleep mode stops the processor clock. All other system and peripheral clocks may still be running.
- Deep sleep mode stops most of the STM32 system and peripheral clocks. At product level, this corresponds to either the Stop or the Standby mode. For more details, please refer to the “Power modes” Section in the STM32 reference manual.

The SLEEPDEEP bit of the SCR selects which sleep mode is used, see [System control register \(SCR\) on page 214](#). For more information about the behavior of the sleep modes see the STM32 product reference manual.

This section describes the mechanisms for entering sleep mode, and the conditions for waking up from sleep mode.

## 2.5.1 Entering sleep mode

This section describes the mechanisms software can use to put the processor into sleep mode.

The system can generate spurious wakeup events, for example a debug operation wakes up the processor. Therefore software must be able to put the processor back into sleep mode after such an event. A program might have an idle loop to put the processor back to sleep mode.

### Wait for interrupt

The *wait for interrupt* instruction, WFI, causes immediate entry to sleep mode (unless the wake-up condition is true, see [Wakeup from WFI or sleep-on-exit on page 47](#)). When the processor executes a WFI instruction it stops executing instructions and enters sleep mode. See [WFI on page 177](#) for more information.

### Wait for event

The *wait for event* instruction, WFE, causes entry to sleep mode depending on the value of a one-bit event register. When the processor executes a WFE instruction, it checks the value of the event register:

- 0: the processor stops executing instructions and enters sleep mode
- 1: the processor clears the register to 0 and continues executing instructions without entering sleep mode.

See [WFE on page 176](#) for more information.

If the event register is 1, this indicates that the processor must not enter sleep mode on execution of a WFE instruction. Typically, this is because an external event signal is asserted, or a processor in the system has executed an SEV instruction, see [SEV on page 175](#). Software cannot access this register directly.

### Sleep-on-exit

If the SLEEPONEXIT bit of the SCR is set to 1, when the processor completes the execution of an exception handler it returns to Thread mode and immediately enters sleep mode. Use this mechanism in applications that only require the processor to run when an exception occurs.

## 2.5.2 Wakeup from sleep mode

The conditions for the processor to wakeup depend on the mechanism that cause it to enter sleep mode.

### Wakeup from WFI or sleep-on-exit

Normally, the processor wakes up only when it detects an exception with sufficient priority to cause exception entry.

Some embedded systems might have to execute system restore tasks after the processor wakes up, and before it executes an interrupt handler. To achieve this set the PRIMASK bit to 1 and the FAULTMASK bit to 0. If an interrupt arrives that is enabled and has a higher priority than current exception priority, the processor wakes up but does not execute the interrupt handler until the processor sets PRIMASK to zero. For more information about PRIMASK and FAULTMASK see [Exception mask registers on page 22](#).

### Wakeup from WFE

The processor wakes up if:

- it detects an exception with sufficient priority to cause exception entry
- it detects an external event signal, see [Section 2.5.3: External event input / extended interrupt and event input](#)
- in a multiprocessor system, another processor in the system executes an SEV instruction.

In addition, if the SEVONPEND bit in the SCR is set to 1, any new pending interrupt triggers an event and wakes up the processor, even if the interrupt is disabled or has insufficient priority to cause exception entry. For more information about the SCR see [System control register \(SCR\) on page 214](#).

### 2.5.3 External event input / extended interrupt and event input

The processor provides an external event input signal.

For the STM32F4xxx series, this signal can be generated by the up to 16 external input lines, by the PVD, RTC alarm or by the USB wakeup event, configured through the external interrupt/event controller (EXTI).

For the STM32F3xxx series, this signal can be generated by the extended interrupt/event controller (EXTI), which manages up to 29 external and internal asynchronous interrupts and events.

This signal can wakeup the processor from WFE, or set the internal WFE event register to one to indicate that the processor must not enter sleep mode on a later WFE instruction, see [Wait for event on page 47](#). For more details please refer to the STM32 reference manual, section 4.3 Low power modes.

### 2.5.4 Power management programming hints

ISO/IEC C cannot directly generate the WFI and WFE instructions. The CMSIS provides the following functions for these instructions:

```
void __WFE(void) // Wait for Event
void __WFI(void) // Wait for Interrupt
```



## 3 The STM32 Cortex-M4 instruction set

This chapter is the reference material for the Cortex-M4 instruction set description in a User Guide. The following sections give general information:

[Section 3.1: Instruction set summary on page 49](#)

[Section 3.2: CMSIS intrinsic functions on page 57](#)

[Section 3.3: About the instruction descriptions on page 59](#)

Each of the following sections describes a functional group of Cortex-M4 instructions. Together they describe all the instructions supported by the Cortex-M4 processor:

[Section 3.4: Memory access instructions on page 68](#)

[Section 3.5: General data processing instructions on page 80](#)

[Section 3.6: Multiply and divide instructions on page 108](#)

[Section 3.7: Saturating instructions on page 124](#)

[Section 3.8: Packing and unpacking instructions on page 132](#)

[Section 3.9: Bitfield instructions on page 136](#)

[Section 3.10: Floating-point instructions on page 148](#)

[Section 3.11: Miscellaneous instructions on page 170](#)

### 3.1 Instruction set summary

The processor implements a version of the thumb instruction set. [Table 21](#) lists the supported instructions.

In [Table 21](#):

- Angle brackets, <>, enclose alternative forms of the operand
- Braces, {}, enclose optional operands
- The operands column is not exhaustive
- Op2 is a flexible second operand that can be either a register or a constant
- Most instructions can use an optional condition code suffix

For more information on the instructions and operands, see the instruction descriptions.

**Table 21. Cortex-M4 instructions**

Mnemonic	Operands	Brief description	Flags	Page
ADC, ADCS	{Rd,} Rn, Op2	Add with carry	N,Z,C,V	<a href="#">3.5.1 on page 82</a>
ADD, ADDS	{Rd,} Rn, Op2	Add	N,Z,C,V	<a href="#">3.5.1 on page 82</a>
ADD, ADDW	{Rd,} Rn, #imm12	Add	N,Z,C,V	<a href="#">3.5.1 on page 82</a>
ADR	Rd, label	Load PC-relative address	—	<a href="#">3.4.1 on page 69</a>

Table 21. Cortex-M4 instructions (continued)

Mnemonic	Operands	Brief description	Flags	Page
AND, ANDS	{Rd,} Rn, Op2	Logical AND	N,Z,C	<a href="#">3.5.2 on page 84</a>
ASR, ASRS	Rd, Rm, <Rs #n>	Arithmetic shift right	N,Z,C	<a href="#">3.5.3 on page 85</a>
B	label	Branch	—	<a href="#">3.9.5 on page 141</a>
BFC	Rd, #lsb, #width	Bit field clear	—	<a href="#">3.9.1 on page 137</a>
BFI	Rd, Rn, #lsb, #width	Bit field insert	—	<a href="#">3.9.1 on page 137</a>
BIC, BICS	{Rd,} Rn, Op2	Bit clear	N,Z,C	<a href="#">3.5.2 on page 84</a>
BKPT	#imm	Breakpoint	—	<a href="#">3.11.1 on page 170</a>
BL	label	Branch with link	—	<a href="#">3.9.5 on page 141</a>
BLX	Rm	Branch indirect with link	—	<a href="#">3.9.5 on page 141</a>
BX	Rm	Branch indirect	—	<a href="#">3.9.5 on page 141</a>
CBNZ	Rn, label	Compare and branch if non zero	—	<a href="#">3.9.6 on page 143</a>
CBZ	Rn, label	Compare and branch if zero	—	<a href="#">3.9.6 on page 143</a>
CLREX	—	Clear exclusive	—	<a href="#">3.4.9 on page 79</a>
CLZ	Rd, Rm	Count leading zeros	—	<a href="#">3.5.4 on page 86</a>
CMN	Rn, Op2	Compare negative	N,Z,C,V	<a href="#">3.5.5 on page 87</a>
CMP	Rn, Op2	Compare	N,Z,C,V	<a href="#">3.5.5 on page 87</a>
CPSID	iflags	Change processor state, disable interrupts	—	<a href="#">3.11.2 on page 171</a>
CPSIE	iflags	Change processor state, enable interrupts	—	<a href="#">3.11.2 on page 171</a>
DMB	—	Data memory barrier	—	<a href="#">3.11.4 on page 172</a>
DSB	—	Data synchronization barrier	—	<a href="#">3.11.4 on page 172</a>
EOR, EORS	{Rd,} Rn, Op2	Exclusive OR	N,Z,C	<a href="#">3.5.2 on page 84</a>
ISB	—	Instruction synchronization barrier	—	<a href="#">3.11.5 on page 173</a>
IT	—	If-then condition block	—	<a href="#">3.9.7 on page 144</a>
LDM	Rn{!}, reglist	Load multiple registers, increment after	—	<a href="#">3.4.6 on page 75</a>
LDMDB, LDMEA	Rn{!}, reglist	Load multiple registers, decrement before	—	<a href="#">3.4.6 on page 75</a>
LDMFD, LDMIA	Rn{!}, reglist	Load multiple registers, increment after	—	<a href="#">3.4.6 on page 75</a>
LDR	Rt, [Rn, #offset]	Load register with word	—	<a href="#">3.4 on page 68</a>
LDRB, LDRBT	Rt, [Rn, #offset]	Load register with byte	—	<a href="#">3.4 on page 68</a>
LDRD	Rt, Rt2, [Rn, #offset]	Load register with two bytes	—	<a href="#">3.4.2 on page 70</a>
LDREX	Rt, [Rn, #offset]	Load register exclusive	—	<a href="#">3.4.8 on page 78</a>

Table 21. Cortex-M4 instructions (continued)

Mnemonic	Operands	Brief description	Flags	Page
LDREXB	Rt, [Rn]	Load register exclusive with byte	—	<a href="#">3.4.8 on page 78</a>
LDREXH	Rt, [Rn]	Load register exclusive with halfword	—	<a href="#">3.4.8 on page 78</a>
LDRH, LDRHT	Rt, [Rn, #offset]	Load register with halfword	—	<a href="#">3.4 on page 68</a>
LDRSB, LDRSBT	Rt, [Rn, #offset]	Load register with signed byte	—	<a href="#">3.4 on page 68</a>
LDRSH, LDRSHT	Rt, [Rn, #offset]	Load register with signed halfword	—	<a href="#">3.4 on page 68</a>
LDRT	Rt, [Rn, #offset]	Load register with word	—	<a href="#">3.4 on page 68</a>
LSL, LSLS	Rd, Rm, <Rs #n>	Logical shift left	N,Z,C	<a href="#">3.5.3 on page 85</a>
LSR, LSRS	Rd, Rm, <Rs #n>	Logical shift right	N,Z,C	<a href="#">3.5.3 on page 85</a>
MLA	Rd, Rn, Rm, Ra	Multiply with accumulate, 32-bit result	—	<a href="#">3.6.1 on page 109</a>
MLS	Rd, Rn, Rm, Ra	Multiply and subtract, 32-bit result	—	<a href="#">3.6.1 on page 109</a>
MOV, MOVS	Rd, Op2	Move	N,Z,C	<a href="#">3.5.6 on page 88</a>
MOVT	Rd, #imm16	Move top	—	<a href="#">3.5.7 on page 90</a>
MOVW, MOV	Rd, #imm16	Move 16-bit constant	N,Z,C	<a href="#">3.5.6 on page 88</a>
MRS	Rd, spec_reg	Move from special register to general register	—	<a href="#">3.11.6 on page 173</a>
MSR	spec_reg, Rm	Move from general register to special register	N,Z,C,V	<a href="#">3.11.7 on page 174</a>
MUL, MULS	{Rd,} Rn, Rm	Multiply, 32-bit result	N,Z	<a href="#">3.6.1 on page 109</a>
MVN, MVNS	Rd, Op2	Move NOT	N,Z,C	<a href="#">3.5.6 on page 88</a>
NOP	—	No operation	—	<a href="#">3.11.8 on page 175</a>
ORN, ORNS	{Rd,} Rn, Op2	Logical OR NOT	N,Z,C	<a href="#">3.5.2 on page 84</a>
ORR, ORRS	{Rd,} Rn, Op2	Logical OR	N,Z,C	<a href="#">3.5.2 on page 84</a>
PKHTB, PKHBT	{Rd,} Rn, Rm, Op2	Pack Halfword		<a href="#">3.8.1 on page 133</a>
POP	reglist	Pop registers from stack	—	<a href="#">3.4.7 on page 77</a>
PUSH	reglist	Push registers onto stack	—	<a href="#">3.4.7 on page 77</a>
QADD	{Rd,} Rn, Rm	Saturating double and add		<a href="#">3.7.3 on page 127</a>
QADD16	{Rd,} Rn, Rm	Saturating add 16		<a href="#">3.7.3 on page 127</a>
QADD8	{Rd,} Rn, Rm	Saturating add 8		<a href="#">3.7.3 on page 127</a>
QASX	{Rd,} Rn, Rm	Saturating add and subtract with exchange		<a href="#">3.7.4 on page 128</a>

Table 21. Cortex-M4 instructions (continued)

Mnemonic	Operands	Brief description	Flags	Page
QDADD	{Rd,} Rn, Rm	Saturating add		<a href="#">3.7.5 on page 129</a>
QDSUB	{Rd,} Rn, Rm	Saturating double and subtract		<a href="#">3.7.5 on page 129</a>
QSAX	{Rd,} Rn, Rm	Saturating subtract and add with exchange		<a href="#">3.7.4 on page 128</a>
QSUB	{Rd,} Rn, Rm	Saturating subtract		<a href="#">3.7.3 on page 127</a>
QSUB16	{Rd,} Rn, Rm	Saturating subtract 16		<a href="#">3.7.4 on page 128</a>
QSUB8	{Rd,} Rn, Rm	Saturating subtract 8		<a href="#">3.7.4 on page 128</a>
RBIT	Rd, Rn	Reverse bits	—	<a href="#">3.7.4 on page 128</a>
REV	Rd, Rn	Reverse byte order in a word	—	<a href="#">3.5.8 on page 91</a>
REV16	Rd, Rn	Reverse byte order in each halfword	—	<a href="#">3.5.8 on page 91</a>
REVSH	Rd, Rn	Reverse byte order in bottom halfword and sign extend	—	<a href="#">3.5.8 on page 91</a>
ROR, RORS	Rd, Rm, <Rs #n>	Rotate right	N,Z,C	<a href="#">3.5.3 on page 85</a>
RRX, RRXS	Rd, Rm	Rotate right with extend	N,Z,C	<a href="#">3.5.3 on page 85</a>
RSB, RSBS	{Rd,} Rn, Op2	Reverse subtract	N,Z,C,V	<a href="#">3.5.1 on page 82</a>
SADD16	{Rd,} Rn, Rm	Signed add 16		<a href="#">3.5.9 on page 92</a>
SADD8	{Rd,} Rn, Rm	Signed add 8		<a href="#">3.5.9 on page 92</a>
SASX	{Rd,} Rn, Rm	Signed add and subtract with exchange		<a href="#">3.5.14 on page 97</a>
SBC, SBCS	{Rd,} Rn, Op2	Subtract with carry	N,Z,C,V	<a href="#">3.5.1 on page 82</a>
SBFX	Rd, Rn, #lsb, #width	Signed bit field extract	—	<a href="#">3.9.2 on page 138</a>
SDIV	{Rd,} Rn, Rm	Signed divide	—	<a href="#">3.6.3 on page 111</a>
SEV	—	Send event	—	<a href="#">3.11.9 on page 175</a>
SHADD16	{Rd,} Rn, Rm	Signed halving add 16	—	<a href="#">3.5.10 on page 93</a>
SHADD8	{Rd,} Rn, Rm	Signed halving add 8	—	<a href="#">3.5.10 on page 93</a>
SHASX	{Rd,} Rn, Rm	Signed halving add and subtract with exchange	—	<a href="#">3.5.11 on page 94</a>
SHSAX	{Rd,} Rn, Rm	Signed halving subtract and add with exchange	—	<a href="#">3.5.11 on page 94</a>
SHSUB16	{Rd,} Rn, Rm	Signed halving subtract 16	—	<a href="#">3.5.12 on page 95</a>
SHSUB8	{Rd,} Rn, Rm	Signed halving subtract 8	—	<a href="#">3.5.12 on page 95</a>
SMLABB, SMLABT, SMLATB, SMLATT	Rd, Rn, Rm, Ra	Signed multiply accumulate long (halfwords)	Q	<a href="#">3.6.3 on page 111</a>
SMLAD, SMLADX	Rd, Rn, Rm, Ra	Signed multiply accumulate dual	Q	<a href="#">3.6.4 on page 113</a>

Table 21. Cortex-M4 instructions (continued)

Mnemonic	Operands	Brief description	Flags	Page
SMLAL	RdLo, RdHi, Rn, Rm	Signed multiply with accumulate (32 x 32 + 64), 64-bit result	—	<a href="#">3.6.2 on page 110</a>
SMLALBB, SMLALBT, SMLALTB, SMLALTT	RdLo, RdHi, Rn, Rm	Signed multiply accumulate long, halfwords	—	<a href="#">3.6.5 on page 114</a>
SMLALD, SMLALDX	RdLo, RdHi, Rn, Rm	Signed multiply accumulate long dual	—	<a href="#">3.6.5 on page 114</a>
SMLAWB, SMLAWT	Rd, Rn, Rm, Ra	Signed multiply accumulate, word by halfword	Q	<a href="#">3.6.3 on page 111</a>
SMLSD	Rd, Rn, Rm, Ra	Signed multiply subtract dual	Q	<a href="#">3.6.6 on page 116</a>
SMLSLD	RdLo, RdHi, Rn, Rm	Signed multiply subtract long dual	—	<a href="#">3.6.6 on page 116</a>
SMMLA	Rd, Rn, Rm, Ra	Signed most significant word multiply accumulate	—	<a href="#">3.6.7 on page 118</a>
SMMLS, SMMLR	Rd, Rn, Rm, Ra	Signed most significant word multiply subtract	—	<a href="#">3.6.7 on page 118</a>
SMMUL, SMMULR	{Rd,} Rn, Rm	Signed most significant word multiply	—	<a href="#">3.6.8 on page 119</a>
SMUAD	{Rd,} Rn, Rm	Signed dual multiply add	Q	<a href="#">3.6.9 on page 120</a>
SMULBB, SMULBT, SMULTB, SMULTT	{Rd,} Rn, Rm	Signed multiply (halfwords)	—	<a href="#">3.6.10 on page 121</a>
SMULL	RdLo, RdHi, Rn, Rm	Signed multiply (32 x 32), 64-bit result	—	<a href="#">3.6.2 on page 110</a>
SSAT	Rd, #n, Rm {,shift #s}	Signed saturate	Q	<a href="#">3.7.1 on page 125</a>
SSAT16	Rd, #n, Rm	Signed saturate 16	Q	<a href="#">3.7.2 on page 126</a>
SSAX	{Rd,} Rn, Rm	Signed subtract and add with exchange	GE	<a href="#">3.5.14 on page 97</a>
SSUB16	{Rd,} Rn, Rm	Signed subtract 16	—	<a href="#">3.5.13 on page 96</a>
SSUB8	{Rd,} Rn, Rm	Signed subtract 8	—	<a href="#">3.5.13 on page 96</a>
STM	Rn{!}, reglist	Store multiple registers, increment after	—	<a href="#">3.4.6 on page 75</a>
STMDB, STMEA	Rn{!}, reglist	Store multiple registers, decrement before	—	<a href="#">3.4.6 on page 75</a>
STMFD, STMIA	Rn{!}, reglist	Store multiple registers, increment after	—	<a href="#">3.4.6 on page 75</a>
STR	Rt, [Rn, #offset]	Store register word	—	<a href="#">3.4 on page 68</a>
STRB, STRBT	Rt, [Rn, #offset]	Store register byte	—	<a href="#">3.4 on page 68</a>

Table 21. Cortex-M4 instructions (continued)

Mnemonic	Operands	Brief description	Flags	Page
STRD	Rt, Rt2, [Rn, #offset]	Store register two words	—	<a href="#">3.4.2 on page 70</a>
STREX	Rd, Rt, [Rn, #offset]	Store register exclusive	—	<a href="#">3.4.8 on page 78</a>
STREXB	Rd, Rt, [Rn]	Store register exclusive byte	—	<a href="#">3.4.8 on page 78</a>
STREXH	Rd, Rt, [Rn]	Store register exclusive halfword	—	<a href="#">3.4.8 on page 78</a>
STRH, STRHT	Rt, [Rn, #offset]	Store register halfword	—	<a href="#">3.4 on page 68</a>
STRT	Rt, [Rn, #offset]	Store register word	—	<a href="#">3.4 on page 68</a>
SUB, SUBS	{Rd,} Rn, Op2	Subtract	N,Z,C,V	<a href="#">3.5.1 on page 82</a>
SUB, SUBW	{Rd,} Rn, #imm12	Subtract	N,Z,C,V	<a href="#">3.5.1 on page 82</a>
SVC	#imm	Supervisor call	—	<a href="#">3.11.10 on page 176</a>
SXTAB	{Rd,} Rn, Rm, {,ROR #}	Extend 8 bits to 32 and add	—	<a href="#">3.8.3 on page 135</a>
SXTAB16	{Rd,} Rn, Rm, {,ROR #}	Dual extend 8 bits to 16 and add	—	<a href="#">3.8.3 on page 135</a>
SXTAH	{Rd,} Rn, Rm, {,ROR #}	Extend 16 bits to 32 and add	—	<a href="#">3.8.3 on page 135</a>
SXTB16	{Rd,} Rm {,ROR #n}	Signed extend byte 16	—	<a href="#">3.8.2 on page 134</a>
SXTB	{Rd,} Rm {,ROR #n}	Sign extend a byte	—	<a href="#">3.9.3 on page 139</a>
SXTH	{Rd,} Rm {,ROR #n}	Sign extend a halfword	—	<a href="#">3.9.3 on page 139</a>
TBB	[Rn, Rm]	Table branch byte	—	<a href="#">3.9.8 on page 146</a>
TBH	[Rn, Rm, LSL #1]	Table branch halfword	—	<a href="#">3.9.8 on page 146</a>
TEQ	Rn, Op2	Test equivalence	N,Z,C	<a href="#">3.5.9 on page 92</a>
TST	Rn, Op2	Test	N,Z,C	<a href="#">3.5.9 on page 92</a>
UADD16	{Rd,} Rn, Rm	Unsigned add 16	GE	<a href="#">3.5.16 on page 99</a>
UADD8	{Rd,} Rn, Rm	Unsigned add 8	GE	<a href="#">3.5.16 on page 99</a>
USAX	{Rd,} Rn, Rm	Unsigned subtract and add with exchange	GE	<a href="#">3.5.17 on page 100</a>
UHADD16	{Rd,} Rn, Rm	Unsigned halving add 16	—	<a href="#">3.5.18 on page 101</a>
UHADD8	{Rd,} Rn, Rm	Unsigned halving add 8	—	<a href="#">3.5.18 on page 101</a>
UHASX	{Rd,} Rn, Rm	Unsigned halving add and subtract with exchange	—	<a href="#">3.5.19 on page 102</a>
UHSAX	{Rd,} Rn, Rm	Unsigned halving subtract and add with exchange	—	<a href="#">3.5.19 on page 102</a>
UHSUB16	{Rd,} Rn, Rm	Unsigned halving subtract 16	—	<a href="#">3.5.20 on page 103</a>
UHSUB8	{Rd,} Rn, Rm	Unsigned halving subtract 8	—	<a href="#">3.5.20 on page 103</a>
UBFX	Rd, Rn, #lsb, #width	Unsigned bit field extract	—	<a href="#">3.9.2 on page 138</a>

Table 21. Cortex-M4 instructions (continued)

Mnemonic	Operands	Brief description	Flags	Page
UDIV	{Rd,} Rn, Rm	Unsigned divide	—	<a href="#">3.6.3 on page 111</a>
UMAAL	RdLo, RdHi, Rn, Rm	Unsigned multiply accumulate accumulate long (32 x 32 + 32 +32), 64-bit result	—	<a href="#">3.6.2 on page 110</a>
UMLAL	RdLo, RdHi, Rn, Rm	Unsigned multiply with accumulate (32 x 32 + 64), 64-bit result	—	<a href="#">3.6.2 on page 110</a>
UMULL	RdLo, RdHi, Rn, Rm	Unsigned multiply (32 x 32), 64-bit result	—	<a href="#">3.6.2 on page 110</a>
UQADD16	{Rd,} Rn, Rm	Unsigned saturating add 16	—	<a href="#">3.7.7 on page 131</a>
UQADD8	{Rd,} Rn, Rm	Unsigned saturating add 8	—	<a href="#">3.7.7 on page 131</a>
UQASX	{Rd,} Rn, Rm	Unsigned saturating add and subtract with exchange	—	<a href="#">3.7.6 on page 130</a>
UQSAX	{Rd,} Rn, Rm	Unsigned saturating subtract and add with exchange	—	<a href="#">3.7.6 on page 130</a>
UQSUB16	{Rd,} Rn, Rm	Unsigned saturating subtract 16	—	<a href="#">3.7.7 on page 131</a>
UQSUB8	{Rd,} Rn, Rm	Unsigned saturating subtract 8	—	<a href="#">3.7.7 on page 131</a>
USAD8	{Rd,} Rn, Rm	Unsigned sum of absolute differences	—	<a href="#">3.5.22 on page 105</a>
USADA8	{Rd,} Rn, Rm, Ra	Unsigned sum of absolute differences and accumulate	—	<a href="#">3.5.23 on page 106</a>
USAT	Rd, #n, Rm {,shift #s}	Unsigned saturate	Q	<a href="#">3.7.1 on page 125</a>
USAT16	Rd, #n, Rm	Unsigned saturate 16	Q	<a href="#">3.7.2 on page 126</a>
UASX	{Rd,} Rn, Rm	Unsigned add and subtract with exchange	GE	<a href="#">3.5.17 on page 100</a>
USUB16	{Rd,} Rn, Rm	Unsigned subtract 16	GE	<a href="#">3.5.24 on page 107</a>
USUB8	{Rd,} Rn, Rm	Unsigned subtract 8	GE	<a href="#">3.5.24 on page 107</a>
UXTAB	{Rd,} Rn, Rm,{,ROR #}	Rotate, extend 8 bits to 32 and add	—	<a href="#">3.8.3 on page 135</a>
UXTAB16	{Rd,} Rn, Rm,{,ROR #}	Rotate, dual extend 8 bits to 16 and add	—	<a href="#">3.8.3 on page 135</a>
UXTAH	{Rd,} Rn, Rm,{,ROR #}	Rotate, unsigned extend and add halfword	—	<a href="#">3.8.3 on page 135</a>
UXTB	{Rd,} Rm {,ROR #n}	Zero extend a byte	—	<a href="#">3.8.2 on page 134</a>
UXTB16	{Rd,} Rm {,ROR #n}	Unsigned extend byte 16	—	<a href="#">3.8.2 on page 134</a>
UXTH	{Rd,} Rm {,ROR #n}	Zero extend a halfword	—	<a href="#">3.8.2 on page 134</a>
VABS.F32	Sd, Sm	Floating-point absolute	—	<a href="#">3.10.1 on page 149</a>
VADD.F32	{Sd,} Sn, Sm	Floating-point add	—	<a href="#">3.10.2 on page 150</a>

Table 21. Cortex-M4 instructions (continued)

Mnemonic	Operands	Brief description	Flags	Page
VCMP.F32	Sd, <Sm   #0.0>	Compare two floating-point registers, or one floating-point register and zero	FPSCR	<a href="#">3.10.3 on page 150</a>
VCMPE.F32	Sd, <Sm   #0.0>	Compare two floating-point registers, or one floating-point register and zero with Invalid Operation check	FPSCR	<a href="#">3.10.3 on page 150</a>
VCVT.S32.F32	Sd, Sm	Convert between floating-point and integer	—	<a href="#">3.10.4 on page 151</a>
VCVT.S16.F32	Sd, Sd, #fbits	Convert between floating-point and fixed point	—	<a href="#">3.10.4 on page 151</a>
VCVTR.S32.F32	Sd, Sm	Convert between floating-point and integer with rounding	—	<a href="#">3.10.4 on page 151</a>
VCVT<B H>.F32.F16	Sd, Sm	Converts half-precision value to single-precision	—	<a href="#">3.10.5 on page 152</a>
VCVTT<B T>.F32.F16	Sd, Sm	Converts single-precision register to half-precision	—	<a href="#">3.10.6 on page 153</a>
VDIV.F32	{Sd,} Sn, Sm	Floating-point divide	—	<a href="#">3.10.7 on page 154</a>
VFMA.F32	{Sd,} Sn, Sm	Floating-point fused multiply accumulate	—	<a href="#">3.10.8 on page 154</a>
VFNMA.F32	{Sd,} Sn, Sm	Floating-point fused negate multiply accumulate	—	<a href="#">3.10.9 on page 155</a>
VFMS.F32	{Sd,} Sn, Sm	Floating-point fused multiply subtract	—	<a href="#">3.10.8 on page 154</a>
VFNMS.F32	{Sd,} Sn, Sm	Floating-point fused negate multiply subtract	—	<a href="#">3.10.9 on page 155</a>
VLDM.F<32 64>	Rn{!}, list	Load multiple extension registers	—	<a href="#">3.10.10 on page 156</a>
VLDR.F<32 64>	<Dd Sd>, [Rn]	Load an extension register from memory	—	<a href="#">3.10.11 on page 157</a>
VLMA.F32	{Sd,} Sn, Sm	Floating-point multiply accumulate	—	<a href="#">3.10.12 on page 158</a>
VLMS.F32	{Sd,} Sn, Sm	Floating-point multiply subtract	—	<a href="#">3.10.12 on page 158</a>
VMOV.F32	Sd, #imm	Floating-point move immediate	—	<a href="#">3.10.13 on page 158</a>
VMOV	Sd, Sm	Floating-point move register	—	<a href="#">3.10.14 on page 159</a>
VMOV	Sn, Rt	Copy ARM core register to single precision	—	<a href="#">3.10.18 on page 162</a>
VMOV	Sm, Sm1, Rt, Rt2	Copy 2 ARM core registers to 2 single precision	—	<a href="#">3.10.17 on page 161</a>



Table 21. Cortex-M4 instructions (continued)

Mnemonic	Operands	Brief description	Flags	Page
VMOV	Dd[x], Rt	Copy ARM core register to scalar	—	<a href="#">3.10.15 on page 159</a>
VMOV	Rt, Dn[x]	Copy scalar to ARM core register	—	<a href="#">3.10.16 on page 160</a>
VMRS	Rt, FPSCR	Move FPSCR to ARM core register or APSR	N,Z,C,V	<a href="#">3.10.19 on page 162</a>
VMSR	FPSCR, Rt	Move to FPSCR from ARM Core register	FPSCR	<a href="#">3.10.20 on page 163</a>
VMUL.F32	{Sd,} Sn, Sm	Floating-point multiply	—	<a href="#">3.10.21 on page 163</a>
VNEG.F32	Sd, Sm	Floating-point negate	—	<a href="#">3.10.22 on page 164</a>
VNMLA.F32	Sd, Sn, Sm	Floating-point multiply and add	—	<a href="#">3.10.23 on page 165</a>
VNMLS.F32	Sd, Sn, Sm	Floating-point multiply and subtract	—	<a href="#">3.10.23 on page 165</a>
VNMUL	{Sd,} Sn, Sm	Floating-point multiply	—	<a href="#">3.10.23 on page 165</a>
VPOP	list	Pop extension registers	—	<a href="#">3.10.24 on page 166</a>
VPUSH	list	Push extension registers	—	<a href="#">3.10.25 on page 166</a>
VSQRT.F32	Sd, Sm	Calculates floating-point square root	—	<a href="#">3.10.26 on page 167</a>
VSTM	Rn{!}, list	Floating-point register store multiple	—	<a href="#">3.10.27 on page 167</a>
WFE	—	Wait for event	—	<a href="#">3.11.11 on page 176</a>
WFI	—	Wait for interrupt	—	<a href="#">3.11.12 on page 177</a>

## 3.2 CMSIS intrinsic functions

ISO/IEC C code cannot directly access some Cortex-M4 instructions. This section describes intrinsic functions that can generate these instructions, provided by the CMSIS and that might be provided by a C compiler. If a C compiler does not support an appropriate intrinsic function, you might have to use an inline assembler to access some instructions.

The CMSIS provides the intrinsic functions listed in [Table 22](#) to generate instructions that ANSI cannot directly access.

**Table 22. CMSIS intrinsic functions to generate some Cortex-M4 instructions**

Instruction	CMSIS intrinsic function
CPSIE I	void __enable_irq(void)
CPSID I	void __disable_irq(void)
CPSIE F	void __enable_fault_irq(void)
CPSID F	void __disable_fault_irq(void)
ISB	void __ISB(void)
DSB	void __DSB(void)
DMB	void __DMB(void)
REV	uint32_t __REV(uint32_t int value)
REV16	uint32_t __REV16(uint32_t int value)
REVSH	uint32_t __REVSH(uint32_t int value)
RBIT	uint32_t __RBIT(uint32_t int value)
SEV	void __SEV(void)
WFE	void __WFE(void)
WFI	void __WFI(void)

The CMSIS also provides a number of functions for accessing the special registers using MRS and MSR instructions (see [Table 23](#)).

**Table 23. CMSIS intrinsic functions to access the special registers**

Special register	Access	CMSIS function
PRIMASK	Read	uint32_t __get_PRIMASK (void)
	Write	void __set_PRIMASK (uint32_t value)
FAULTMASK	Read	uint32_t __get_FAULTMASK (void)
	Write	void __set_FAULTMASK (uint32_t value)
BASEPRI	Read	uint32_t __get_BASEPRI (void)
	Write	void __set_BASEPRI (uint32_t value)
CONTROL	Read	uint32_t __get_CONTROL (void)
	Write	void __set_CONTROL (uint32_t value)
MSP	Read	uint32_t __get_MSP (void)
	Write	void __set_MSP (uint32_t TopOfMainStack)
PSP	Read	uint32_t __get_PSP (void)
	Write	void __set_PSP (uint32_t TopOfProcStack)

## 3.3 About the instruction descriptions

The following sections give more information about using the instructions:

- [Operands on page 59](#)
- [Restrictions when using PC or SP on page 59](#)
- [Flexible second operand on page 59](#)
- [Shift operations on page 61](#)
- [Address alignment on page 64](#)
- [PC-relative expressions on page 64](#)
- [Conditional execution on page 64](#)
- [Instruction width selection on page 67](#).

### 3.3.1 Operands

An instruction operand can be an ARM register, a constant, or another instruction-specific parameter. Instructions act on the operands and often store the result in a destination register. When there is a destination register in the instruction, it is usually specified before the operands.

Operands in some instructions are flexible in that they can either be a register or a constant (see [Flexible second operand](#)).

### 3.3.2 Restrictions when using PC or SP

Many instructions have restrictions on whether you can use the *program counter* (PC) or *stack pointer* (SP) for the operands or destination register. See instruction descriptions for more information.

Bit[0] of any address written to the PC with a BX, BLX, LDM, LDR, or POP instruction must be 1 for correct execution, because this bit indicates the required instruction set, and the Cortex-M4 processor only supports thumb instructions.

### 3.3.3 Flexible second operand

Many general data processing instructions have a flexible second operand. This is shown as *operand2* in the descriptions of the syntax of each instruction.

*Operand2* can be a:

- [Constant](#)
- [Register with optional shift](#)

## Constant

You specify an operand2 constant in the form *#constant*, where *constant* can be:

- Any constant that can be produced by shifting an 8-bit value left by any number of bits within a 32-bit word.
- Any constant of the form 0x00XY00XY
- Any constant of the form 0xXY00XY00
- Any constant of the form 0xXYXYXYXY

In the constants shown above, X and Y are hexadecimal digits.

In addition, in a small number of instructions, *constant* can take a wider range of values. These are described in the individual instruction descriptions.

When an operand2 constant is used with the instructions MOVNS, MVNS, ANDS, ORRS, ORNS, EORS, BICS, TEQ or TST, the carry flag is updated to bit[31] of the constant, if the constant is greater than 255 and can be produced by shifting an 8-bit value. These instructions do not affect the carry flag if operand2 is any other constant.

## Instruction substitution

Your assembler might be able to produce an equivalent instruction in cases where you specify a constant that is not permitted. For example, an assembler might assemble the instruction `CMP Rd, #0xFFFFFFFFE` as the equivalent instruction `CMN Rd, #0x2`.

## Register with optional shift

An operand2 register is specified in the form *Rm* {, *shift*}, where:

- *Rm* is the register holding the data for the second operand
- *Shift* is an optional shift to be applied to *Rm*. It can be one of:
  - ASR *#n*: Arithmetic shift right *n* bits,  $1 \leq n \leq 32$
  - LSL *#n*: Logical shift left *n* bits,  $1 \leq n \leq 31$
  - LSR *#n*: Logical shift right *n* bits,  $1 \leq n \leq 32$
  - ROR *#n*: Rotate right *n* bits,  $1 \leq n \leq 31$
  - RRX: Rotate right one bit, with extend
  - : If omitted, no shift occurs, equivalent to LSL #0

If you omit the shift, or specify LSL #0, the instruction uses the value in *Rm*.

If you specify a shift, the shift is applied to the value in *Rm*, and the resulting 32-bit value is used by the instruction. However, the contents in the register *Rm* remains unchanged. Specifying a register with shift also updates the carry flag when used with certain instructions. For information on the shift operations and how they affect the carry flag, see [Shift operations](#).

### 3.3.4 Shift operations

Register shift operations move the bits in a register left or right by a specified number of bits, the *shift length*. Register shift can be performed:

- Directly by the instructions ASR, LSR, LSL, ROR, and RRX. The result is written to a destination register.
- During the calculation of operand2 by the instructions that specify the second operand as a register with shift (see [Flexible second operand on page 59](#)). The result is used by the instruction.

The permitted shift lengths depend on the shift type and the instruction (see the individual instruction description or [Flexible second operand](#)). If the shift length is 0, no shift occurs. Register shift operations update the carry flag except when the specified shift length is 0. The following sub-sections describe the various shift operations and how they affect the carry flag. In these descriptions, *Rm* is the register containing the value to be shifted, and *n* is the shift length.

#### ASR

Arithmetic shift right by *n* bits moves the left-hand  $32-n$  bits of the register *Rm*, to the right by *n* places, into the right-hand  $32-n$  bits of the result. And it copies the original bit[31] of the register into the left-hand *n* bits of the result (see [Figure 13: ASR#3 on page 61](#)).

You can use the ASR #*n* operation to divide the value in the register *Rm* by  $2^n$ , with the result being rounded towards negative-infinity.

When the instruction is ASRS or when ASR #*n* is used in operand2 with the instructions MOV, MVNS, ANDS, ORRS, ORNS, EORS, BICS, TEQ or TST, the carry flag is updated to the last bit shifted out, bit[*n*-1], of the register *Rm*.

- Note:**
- 1 If *n* is 32 or more, all the bits in the result are set to the value of bit[31] of *Rm*.
  - 2 If *n* is 32 or more and the carry flag is updated, it is updated to the value of bit[31] of *Rm*.

Figure 13. ASR#3

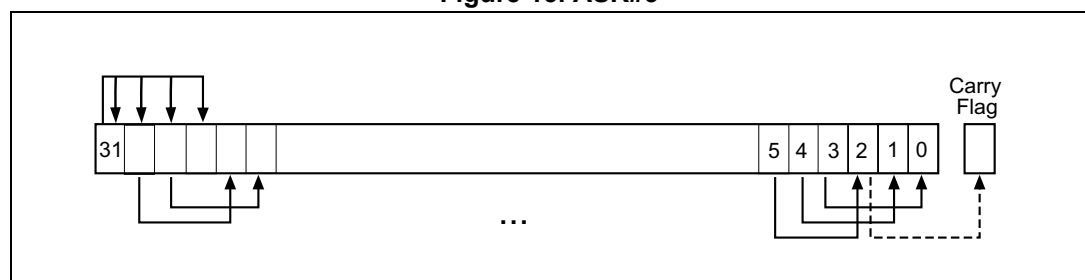

#### LSR

Logical shift right by *n* bits moves the left-hand  $32-n$  bits of the register *Rm*, to the right by *n* places, into the right-hand  $32-n$  bits of the result. And it sets the left-hand *n* bits of the result to 0 (see [Figure 14](#)).

You can use the LSR #*n* operation to divide the value in the register *Rm* by  $2^n$ , if the value is regarded as an unsigned integer.

When the instruction is LSRS or when LSR #*n* is used in *operand2* with the instructions MOV<sub>S</sub>, MVNS, AND<sub>S</sub>, ORR<sub>S</sub>, ORN<sub>S</sub>, EOR<sub>S</sub>, BIC<sub>S</sub>, TEQ or TST, the carry flag is updated to the last bit shifted out, bit[*n*-1], of the register *Rm*.

- Note:
- 1 If *n* is 32 or more, then all the bits in the result are cleared to 0.
  - 2 If *n* is 33 or more and the carry flag is updated, it is updated to 0.

Figure 14. LSR#3

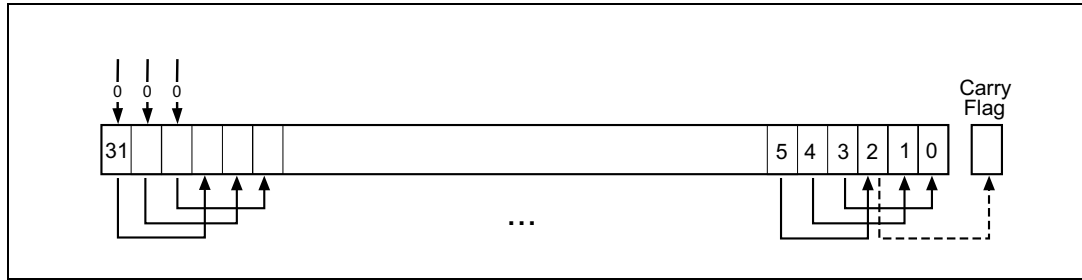

**LSL**

Logical shift left by *n* bits moves the right-hand 32-*n* bits of the register *Rm*, to the left by *n* places, into the left-hand 32-*n* bits of the result. And it sets the right-hand *n* bits of the result to 0 (see [Figure 15: LSL#3 on page 62](#)).

You can use the LSL #*n* operation to multiply the value in the register *Rm* by  $2^n$ , if the value is regarded as an unsigned integer or a two’s complement signed integer. Overflow can occur without warning.

When the instruction is LSL<sub>S</sub> or when LSL #*n*, with non-zero *n*, is used in *operand2* with the instructions MOV<sub>S</sub>, MVNS, AND<sub>S</sub>, ORR<sub>S</sub>, ORN<sub>S</sub>, EOR<sub>S</sub>, BIC<sub>S</sub>, TEQ or TST, the carry flag is updated to the last bit shifted out, bit[32-*n*], of the register *Rm*. These instructions do not affect the carry flag when used with LSL #0.

- Note:
- 1 If *n* is 32 or more, then all the bits in the result are cleared to 0.
  - 2 If *n* is 33 or more and the carry flag is updated, it is updated to 0.

Figure 15. LSL#3

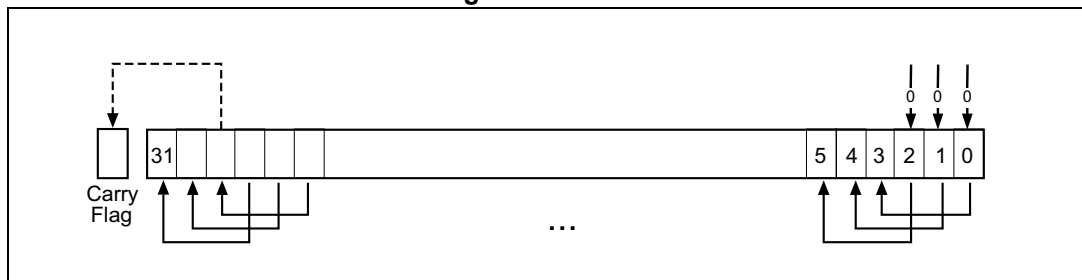

### ROR

Rotate right by  $n$  bits moves the left-hand  $32-n$  bits of the register  $Rm$ , to the right by  $n$  places, into the right-hand  $32-n$  bits of the result. It also moves the right-hand  $n$  bits of the register into the left-hand  $n$  bits of the result (see [Figure 16](#)).

When the instruction is RORS or when ROR # $n$  is used in *operand2* with the instructions MOV<sub>S</sub>, MVNS, AND<sub>S</sub>, ORR<sub>S</sub>, ORN<sub>S</sub>, EOR<sub>S</sub>, BIC<sub>S</sub>, TEQ or TST, the carry flag is updated to the last bit rotation, bit[ $n-1$ ], of the register  $Rm$ .

- Note:
- 1 If  $n$  is 32, then the value of the result is same as the value in  $Rm$ , and if the carry flag is updated, it is updated to bit[31] of  $Rm$ .
  - 2 ROR with shift length,  $n$ , more than 32 is the same as ROR with shift length  $n-32$ .

Figure 16. ROR #3

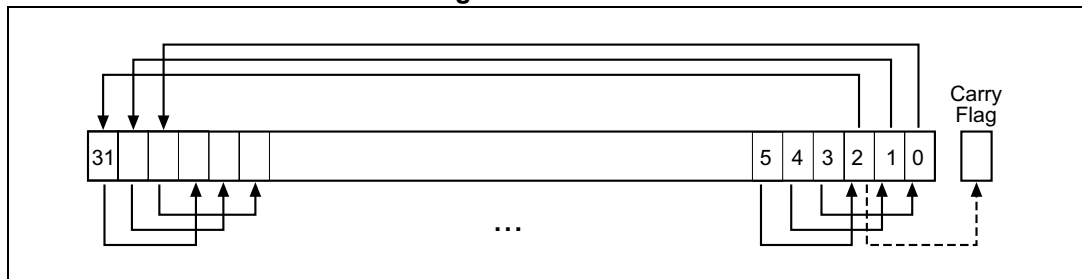

### RRX

Rotate right with extend moves the bits of the register  $Rm$  to the right by one bit. And it copies the carry flag into bit[31] of the result (see [Figure 17](#)).

When the instruction is RRXS or when RRX is used in *operand2* with the instructions MOV<sub>S</sub>, MVNS, AND<sub>S</sub>, ORR<sub>S</sub>, ORN<sub>S</sub>, EOR<sub>S</sub>, BIC<sub>S</sub>, TEQ or TST, the carry flag is updated to bit[0] of the register  $Rm$ .

Figure 17. RRX #3

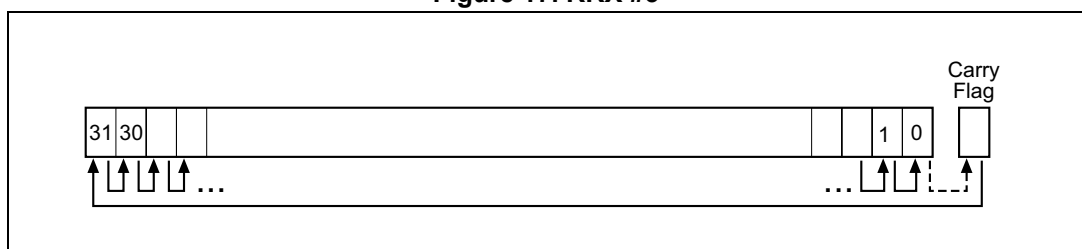

### 3.3.5 Address alignment

An aligned access is an operation where a word-aligned address is used for a word, dual word, or multiple word access, or where a halfword-aligned address is used for a halfword access. Byte accesses are always aligned.

The Cortex-M4 processor supports unaligned access only for the following instructions:

- LDR, LDRT
- LDRH, LDRHT
- LDRSH, LDRSHT
- STR, STRT
- STRH, STRHT

All other load and store instructions generate a usage fault exception if they perform an unaligned access, and therefore their accesses must be address aligned. For more information about usage faults see [Fault handling on page 43](#).

Unaligned accesses are usually slower than aligned accesses. In addition, some memory regions might not support unaligned accesses. Therefore, ARM recommends that programmers ensure that accesses are aligned. To avoid accidental generation of unaligned accesses, use the UNALIGN\_TRP bit in the configuration and control register to trap all unaligned accesses, see [Configuration and control register \(CCR\) on page 215](#).

### 3.3.6 PC-relative expressions

A PC-relative expression or *label* is a symbol that represents the address of an instruction or literal data. It is represented in the instruction as the PC value plus or minus a numeric offset. The assembler calculates the required offset from the label and the address of the current instruction. If the offset is too big, the assembler produces an error.

- For the B, BL, CBNZ, and CBZ instructions, the value of the PC is the address of the current instruction plus four bytes.
- For all other instructions that use labels, the value of the PC is the address of the current instruction plus four bytes, with bit[1] of the result cleared to 0 to make it word-aligned.
- Your assembler might permit other syntaxes for PC-relative expressions, such as a label plus or minus a number, or an expression of the form [PC, #number].

### 3.3.7 Conditional execution

Most data processing instructions can optionally update the condition flags in the *application program status register* (APSR) according to the result of the operation (see [Application program status register on page 20](#)). Some instructions update all flags, and some only update a subset. If a flag is not updated, the original value is preserved. See the instruction descriptions for the flags they affect.

You can execute an instruction conditionally, based on the condition flags set in another instruction:

- Immediately after the instruction that updated the flags
- After any number of intervening instructions that have not updated the flags



Conditional execution is available by using conditional branches or by adding condition code suffixes to instructions. See [Table 24: Condition code suffixes on page 66](#) for a list of the suffixes to add to instructions to make them conditional instructions. The condition code suffix enables the processor to test a condition based on the flags. If the condition test of a conditional instruction fails, the instruction:

- Does not execute
- Does not write any value to its destination register
- Does not affect any of the flags
- Does not generate any exception

Conditional instructions, except for conditional branches, must be inside an If-then instruction block. See [IT on page 144](#) for more information and restrictions when using the IT instruction. Depending on the vendor, the assembler might automatically insert an IT instruction if you have conditional instructions outside the IT block.

Use the CBZ and CBNZ instructions to compare the value of a register against zero and branch on the result.

This section describes:

- [The condition flags](#)
- [Condition code suffixes on page 66](#)

### The condition flags

The APSR contains the following condition flags:

- N: Set to 1 when the result of the operation is negative, otherwise cleared to 0
- Z: Set to 1 when the result of the operation is zero, otherwise cleared to 0
- C: Set to 1 when the operation results in a carry, otherwise cleared to 0.
- V: Set to 1 when the operation causes an overflow, otherwise cleared to 0.

For more information about the APSR see [Program status register on page 18](#).

A carry occurs:

- If the result of an addition is greater than or equal to  $2^{32}$
- If the result of a subtraction is positive or zero
- As the result of an inline barrel shifter operation in a move or logical instruction

Overflow occurs if the sign of a result does not match the sign of the result had the operation been performed at infinite precision, for example:

- if adding two negative values results in a positive value
- if adding two positive values results in a negative value
- if subtracting a positive value from a negative value generates a positive value
- if subtracting a negative value from a positive value generates a negative value.

The Compare operations are identical to subtracting, for CMP, or adding, for CMN, except that the result is discarded. See the instruction descriptions for more information.

Most instructions update the status flags only if the S suffix is specified. See the instruction descriptions for more information.

### Condition code suffixes

The instructions that can be conditional have an optional condition code, shown in syntax descriptions as {*cond*}. Conditional execution requires a preceding IT instruction. An instruction with a condition code is only executed if the condition code flags in the APSR meet the specified condition. [Table 24](#) shows the condition codes to use.

You can use conditional execution with the IT instruction to reduce the number of branch instructions in code.

[Table 24](#) also shows the relationship between condition code suffixes and the N, Z, C, and V flags.

**Table 24. Condition code suffixes**

Suffix	Flags	Meaning
EQ	Z = 1	Equal
NE	Z = 0	Not equal
CS or HS	C = 1	Higher or same, unsigned $\geq$
CC or LO	C = 0	Lower, unsigned $<$
MI	N = 1	Negative
PL	N = 0	Positive or zero
VS	V = 1	Overflow
VC	V = 0	No overflow
HI	C = 1 and Z = 0	Higher, unsigned $>$
LS	C = 0 or Z = 1	Lower or same, unsigned $\leq$
GE	N = V	Greater than or equal, signed $\geq$
LT	N $\neq$ V	Less than, signed $<$
GT	Z = 0 and N = V	Greater than, signed $>$
LE	Z = 1 and N $\neq$ V	Less than or equal, signed $\leq$
AL	Can have any value	Always. This is the default when no suffix is specified.

[Specific example 1: Absolute value](#) shows the use of a conditional instruction to find the absolute value of a number.  $R0 = ABS(R1)$ .

#### Specific example 1: Absolute value

```
MOVSR0, R1; R0 = R1, setting flags
IT MI;                IT instruction for the negative condition
RSBMIR0, R1, #0;     If negative, R0 = -R1
```

[Specific example 2: Compare and update value](#) shows the use of conditional instructions to update the value of R4 if the signed value R0 and R2 are greater than R1 and R3 respectively.

#### Specific example 2: Compare and update value

```
CMP R0, R1 ;         compare R0 and R1, setting flags
ITT GT ;            IT instruction for the two GT conditions
```

```
CMPGT R2, R3;      if 'greater than', compare R2 and R3, setting flags
MOVGT R4, R5 ;     if still 'greater than', do R4 = R5
```

### 3.3.8 Instruction width selection

There are many instructions that can generate either a 16-bit encoding or a 32-bit encoding depending on the operands and destination register specified. For some of these instructions, you can force a specific instruction size by using an instruction width suffix. The `.W` suffix forces a 32-bit instruction encoding. The `.N` suffix forces a 16-bit instruction encoding.

If you specify an instruction width suffix and the assembler cannot generate an instruction encoding of the requested width, it generates an error.

In some cases it might be necessary to specify the `.W` suffix, for example if the operand is the label of an instruction or literal data, as in the case of branch instructions. This is because the assembler might not automatically generate the right size encoding.

To use an instruction width suffix, place it immediately after the instruction mnemonic and condition code, if any. [Specific example 3: Instruction width selection](#) shows instructions with the instruction width suffix.

#### Specific example 3: Instruction width selection

```
BCS.W label;      creates 32-bit instruction even for a short branch
ADDS.W R0, R0, R1; creates a 32-bit instruction even though the same
                  ; operation can be done by a 16-bit instruction
```

### 3.4 Memory access instructions

Table 25 shows the memory access instructions:

**Table 25. Memory access instructions**

Mnemonic	Brief description	See
ADR	Load PC-relative address	<a href="#">ADR on page 69</a>
CLREX	Clear exclusive	<a href="#">CLREX on page 79</a>
LDM{mode}	Load multiple registers	<a href="#">LDM and STM on page 75</a>
LDR{type}	Load register using immediate offset	<a href="#">LDR and STR, immediate offset on page 70</a>
LDR{type}	Load register using register offset	<a href="#">LDR and STR, register offset on page 72</a>
LDR{type}T	Load register with unprivileged access	<a href="#">LDR and STR, unprivileged on page 73</a>
LDR	Load register using PC-relative address	<a href="#">LDR, PC-relative on page 74</a>
LDRD	Load register dual	<a href="#">LDR and STR, immediate offset on page 70</a>
LDREX{type}	Load register exclusive	<a href="#">LDREX and STREX on page 78</a>
POP	Pop registers from stack	<a href="#">PUSH and POP on page 77</a>
PUSH	Push registers onto stack	<a href="#">PUSH and POP on page 77</a>
STM{mode}	Store multiple registers	<a href="#">LDM and STM on page 75</a>
STR{type}	Store register using immediate offset	<a href="#">LDR and STR, immediate offset on page 70</a>
STR{type}	Store register using register offset	<a href="#">LDR and STR, register offset on page 72</a>
STR{type}T	Store register with unprivileged access	<a href="#">LDR and STR, unprivileged on page 73</a>
STREX{type}	Store register exclusive	<a href="#">LDREX and STREX on page 78</a>

### 3.4.1 ADR

Load PC-relative address.

#### Syntax

```
ADR{cond} Rd, label
```

where:

- ‘*cond*’ is an optional condition code (see [Conditional execution on page 64](#))
- ‘*Rd*’ is the destination register
- ‘*label*’ is a PC-relative expression (see [PC-relative expressions on page 64](#))

#### Operation

ADR determines the address by adding an immediate value to the PC. It writes the result to the destination register.

ADR produces position-independent code, because the address is PC-relative.

If you use ADR to generate a target address for a BX or BLX instruction, you must ensure that bit[0] of the address you generate is set to 1 for correct execution.

Values of *label* must be within the range -4095 to 4095 from the address in the PC.

*Note:* You might have to use the *.W* suffix to get the maximum offset range or to generate addresses that are not word-aligned (see [Instruction width selection on page 67](#)).

#### Restrictions

*Rd* must be neither SP nor PC.

#### Condition flags

This instruction does not change the flags.

#### Examples

```
ADR R1, TextMessage; write address value of a location labelled as  
; TextMessage to R1
```

### 3.4.2 LDR and STR, immediate offset

Load and store with immediate offset, pre-indexed immediate offset, or post-indexed immediate offset.

#### Syntax

```
op{type}{cond} Rt, [Rn {, #offset}]; immediate offset
op{type}{cond} Rt, [Rn, #offset]!; pre-indexed
op{type}{cond} Rt, [Rn], #offset; post-indexed
opD{cond} Rt, Rt2, [Rn {, #offset}]; immediate offset, two words
opD{cond} Rt, Rt2, [Rn, #offset]!; pre-indexed, two words
opD{cond} Rt, Rt2, [Rn], #offset; post-indexed, two words
```

where:

- ‘*op*’ is either LDR (load register) or STR (store register)
- ‘*type*’ is one of the following:
  - B: Unsigned byte, zero extends to 32 bits on loads
  - SB: Signed byte, sign extends to 32 bits (LDR only)
  - H: Unsigned halfword, zero extends to 32 bits on loads
  - SH: Signed halfword, sign extends to 32 bits (LDR only)
  - : Omit, for word
- ‘*cond*’ is an optional condition code (see [Conditional execution on page 64](#))
- ‘*Rt*’ is the register to load or store
- ‘*Rn*’ is the register on which the memory address is based
- ‘*offset*’ is an offset from *Rn*. If *offset* is omitted, the address is the contents of *Rn*
- ‘*Rt2*’ is the additional register to load or store for two-word operations

#### Operation

LDR instructions load one or two registers with a value from memory. STR instructions store one or two register values to memory.

Load and store instructions with immediate offset can use the following addressing modes:

- Offset addressing
 

The offset value is added to or subtracted from the address obtained from the register *Rn*. The result is used as the address for the memory access. The register *Rn* is unaltered. The assembly language syntax for this mode is: `[Rn, #offset]`.
- Pre-indexed addressing
 

The offset value is added to or subtracted from the address obtained from the register *Rn*. The result is used as the address for the memory access and written back into the register *Rn*. The assembly language syntax for this mode is: `[Rn, #offset]!`
- Post-indexed addressing
 

The address obtained from the register *Rn* is used as the address for the memory access. The offset value is added to or subtracted from the address, and written back into the register *Rn*. The assembly language syntax for this mode is: `[Rn], #offset`.

The value to load or store can be a byte, halfword, word, or two words. Bytes and halfwords can either be signed or unsigned (see [Address alignment on page 64](#)).

Table 26 shows the range of offsets for immediate, pre-indexed and post-indexed forms.

**Table 26. Immediate, pre-indexed and post-indexed offset ranges**

Instruction type	Immediate offset	Pre-indexed	Post-indexed
Word, halfword, signed halfword, byte, or signed byte	-255 to 4095	-255 to 255	-255 to 255
Two words	Multiple of 4 in the range -1020 to 1020	Multiple of 4 in the range -1020 to 1020	Multiple of 4 in the range -1020 to 1020

### Restrictions

- For load instructions
  - *Rt* can be SP or PC for word loads only
  - *Rt* must be different from *Rt2* for two-word loads
  - *Rn* must be different from *Rt* and *Rt2* in the pre-indexed or post-indexed forms
- When *Rt* is PC in a word load instruction
  - bit[0] of the loaded value must be 1 for correct execution
  - A branch occurs to the address created by changing bit[0] of the loaded value to 0
  - If the instruction is conditional, it must be the last instruction in the IT block
- For store instructions
  - *Rt* can be SP for word stores only
  - *Rt* must not be PC
  - *Rn* must not be PC
  - *Rn* must be different from *Rt* and *Rt2* in the pre-indexed or post-indexed forms

### Condition flags

These instructions do not change the flags.

### Examples

```
LDR R8, [R10]           ; loads R8 from the address in R10.
LDRNE R2, [R5, #960]!; loads (conditionally) R2 from a word
                        ; 960 bytes above the address in R5, and
                        ; increments R5 by 960.
STR R2, [R9,#const-struct]; const-struct is an expression evaluating
                        ; to a constant in the range 0-4095.
STRH R3, [R4], #4; Store R3 as halfword data into address in
                ; R4, then increment R4 by 4
LDRD R8, R9, [R3, #0x20]; Load R8 from a word 32 bytes above the
                        ; address in R3, and load R9 from a word 36
                        ; bytes above the address in R3
STRD R0, R1, [R8], #-16; Store R0 to address in R8, and store R1 to
                        ; a word 4 bytes above the address in R8,
                        ; and then decrement R8 by 16.
```

### 3.4.3 LDR and STR, register offset

Load and store with register offset.

#### Syntax

```
op{type}{cond} Rt, [Rn, Rm {, LSL #n}]
```

where:

- ‘*op*’ is either LDR (load register) or STR (store register)
- ‘*type*’ is one of the following:
  - B: Unsigned byte, zero extends to 32 bits on loads
  - SB: Signed byte, sign extends to 32 bits (LDR only)
  - H: Unsigned halfword, zero extends to 32 bits on loads
  - SH: Signed halfword, sign extends to 32 bits (LDR only)
  - : Omit, for word
- ‘*cond*’ is an optional condition code (see [Conditional execution on page 64](#))
- ‘*Rt*’ is the register to load or store
- ‘*Rn*’ is the register on which the memory address is based
- ‘*Rm*’ is a register containing a value to be used as the offset
- ‘*LSL #n*’ is an optional shift, with *n* in the range 0 to 3

#### Operation

LDR instructions load a register with a value from memory. STR instructions store a register value into memory. The memory address to load from or store to is at an offset from the register *Rn*. The offset is specified by the register *Rm* and can be shifted left by up to 3 bits using LSL. The value to load or store can be a byte, halfword, or word. For load instructions, bytes and halfwords can either be signed or unsigned (see [Address alignment on page 64](#)).

#### Restrictions

In these instructions:

- *Rn* must not be PC
- *Rm* must be neither SP nor PC
- *Rt* can be SP only for word loads and word stores
- *Rt* can be PC only for word loads

When *Rt* is PC in a word load instruction:

- bit[0] of the loaded value must be 1 for correct execution, and a branch occurs to this halfword-aligned address
- If the instruction is conditional, it must be the last instruction in the IT block.

#### Condition flags

These instructions do not change the flags.

#### Examples

```
STR R0, [R5, R1]; store value of R0 into an address equal to
                ; sum of R5 and R1
LDRSB R0, [R5, R1, LSL #1]; read byte value from an address equal to
```



```

; sum of R5 and two times R1, sign extended it
; to a word value and put it in R0
STR R0, [R1, R2, LSL #2]; stores R0 to an address equal to sum of R1
; and four times R2

```

### 3.4.4 LDR and STR, unprivileged

Load and store with unprivileged access.

#### Syntax

```
op{type}T{cond} Rt, [Rn {, #offset}]; immediate offset
```

where:

- ‘*op*’ is either LDR (load register) or STR (store register)
- ‘*type*’ is one of the following:
  - B: Unsigned byte, zero extends to 32 bits on loads
  - SB: Signed byte, sign extends to 32 bits (LDR only)
  - H: Unsigned halfword, zero extends to 32 bits on loads
  - SH: Signed halfword, sign extends to 32 bits (LDR only)
  - : Omit, for word
- ‘*cond*’ is an optional condition code (see [Conditional execution on page 64](#))
- ‘*Rt*’ is the register to load or store
- ‘*Rn*’ is the register on which the memory address is based
- ‘*offset*’ is an offset from *Rn* and can be 0 to 255. If *offset* is omitted, the address is the value in *Rn*.

#### Operation

These load and store instructions perform the same function as the memory access instructions with immediate offset (see [LDR and STR, immediate offset on page 70](#)). The difference is that these instructions have only unprivileged access even when used in privileged software.

When used in unprivileged software, these instructions behave in exactly the same way as normal memory access instructions with immediate offset.

#### Restrictions

In these instructions:

- *Rn* must not be PC
- *Rt* must be neither SP nor PC.

#### Condition flags

These instructions do not change the flags.

#### Examples

```

STRBTEQ R4, [R7] ; conditionally store least significant byte in
; R4 to an address in R7, with unprivileged access
LDRHT R2, [R2, #8]; load halfword value from an address equal to

```

; sum of R2 and 8 into R2, with unprivileged access

### 3.4.5 LDR, PC-relative

Load register from memory.

#### Syntax

```
LDR{type}{cond} Rt, label
LDRD{cond} Rt, Rt2, label; load two words
```

where:

- ‘type’ is one of the following:
  - B: Unsigned byte, zero extends to 32 bits
  - SB: Signed byte, sign extends to 32 bits
  - H: Unsigned halfword, sign extends to 32 bits
  - SH: Signed halfword, sign extends to 32 bits
  - : Omit, for word
- ‘cond’ is an optional condition code (see [Conditional execution on page 64](#))
- ‘Rt’ is the register to load or store
- ‘Rt2’ is the second register to load or store
- ‘label’ is a PC-relative expression (see [PC-relative expressions on page 64](#))

#### Operation

LDR loads a register with a value from a PC-relative memory address. The memory address is specified by a label or by an offset from the PC. The value to load or store can be a byte, halfword, or word. For load instructions, bytes and halfwords can either be signed or unsigned (see [Address alignment on page 64](#)).

‘label’ must be within a limited range of the current instruction. [Table 27](#) shows the possible offsets between *label* and the PC. You might have to use the .W suffix to get the maximum offset range (see [Instruction width selection on page 67](#)).

**Table 27. label-PC offset ranges**

Instruction type	Offset range
Word, halfword, signed halfword, byte, signed byte	-4095 to 4095
Two words	-1020 to 1020

#### Restrictions

In these instructions:

- Rt2 must be neither SP nor PC
- Rt must be different from Rt2
- Rt can be SP or PC only for word loads
- When Rt is PC in a word load instruction: bit[0] of the loaded value must be 1 for correct execution, and a branch occurs to this halfword-aligned address. If the instruction is conditional, it must be the last instruction in the IT block.

## Condition flags

These instructions do not change the flags.

## Examples

```
LDR R0, LookUpTable; load R0 with a word of data from an address
                    ; labelled as LookUpTable
LDRSB R7, localdata; load a byte value from an address labelled
                    ; as localdata, sign extend it to a word
                    ; value, and put it in R7
```

## 3.4.6 LDM and STM

Load and store multiple registers.

### Syntax

```
op{addr_mode}{cond} Rn{!}, reglist
```

where:

- ‘*op*’ is either LDM (load multiple register) or STM (store multiple register)
- ‘*addr\_mode*’ is any of the following:
  - IA: Increment address after each access (this is the default)
  - DB: Decrement address before each access
- ‘*cond*’ is an optional condition code (see [Conditional execution on page 64](#))
- ‘*Rn*’ is the register on which the memory addresses are based
- ‘!’ is an optional writeback suffix. If ! is present, the final address that is loaded from or stored to is written back into *Rn*.
- ‘*reglist*’ is a list of one or more registers to be loaded or stored, enclosed in braces. It can contain register ranges. It must be comma-separated if it contains more than one register or register range (see [Examples on page 76](#)).

LDM and LDMFD are synonyms for LDMIA. LDMFD refers to its use for popping data from full descending stacks.

LDMEA is a synonym for LDMDB, and refers to its use for popping data from empty ascending stacks.

STM and STMEA are synonyms for STMIA. STMEA refers to its use for pushing data onto empty ascending stacks.

STMFD is a synonym for STMDB, and refers to its use for pushing data onto full descending stacks

### Operation

LDM instructions load the registers in *reglist* with word values from memory addresses based on *Rn*.

STM instructions store the word values in the registers in *reglist* to memory addresses based on *Rn*.

For LDM, LDMIA, LDMFD, STM, STMIA, and STMEA the memory addresses used for the accesses are at 4-byte intervals ranging from *Rn* to  $Rn + 4 * (n-1)$ , where *n* is the number of

registers in *reglist*. The accesses happen in order of increasing register numbers, with the lowest numbered register using the lowest memory address and the highest number register using the highest memory address. If the writeback suffix is specified, the value of  $Rn + 4 * (n-1)$  is written back to  $Rn$ .

For LDMDB, LDMEA, STMDB, and STMFD the memory addresses used for the accesses are at 4-byte intervals ranging from  $Rn$  to  $Rn - 4 * (n-1)$ , where  $n$  is the number of registers in *reglist*. The accesses happen in order of decreasing register numbers, with the highest numbered register using the highest memory address and the lowest number register using the lowest memory address. If the writeback suffix is specified, the value  $Rn - 4 * (n)$  is written back to  $Rn$ .

The PUSH and POP instructions can be expressed in this form (see [PUSH and POP](#) for details).

### Restrictions

In these instructions:

- $Rn$  must not be PC
- *reglist* must not contain SP
- In any STM instruction, *reglist* must not contain PC
- In any LDM instruction, *reglist* must not contain PC if it contains LR
- *reglist* must not contain  $Rn$  if you specify the writeback suffix

When PC is in *reglist* in an LDM instruction:

- bit[0] of the value loaded to the PC must be 1 for correct execution, and a branch occurs to this halfword-aligned address.
- If the instruction is conditional, it must be the last instruction in the IT block

### Condition flags

These instructions do not change the flags.

### Examples

```
LDM R8, {R0,R2,R9} ; LDMIA is a synonym for LDM
STMDB R1!, {R3-R6,R11,R12}
```

### Incorrect examples

```
STM R5!, {R5,R4,R9} ; value stored for R5 is unpredictable
LDM R2, {} ; there must be at least one register in the list
```

### 3.4.7 PUSH and POP

Push registers onto, and pop registers off a full-descending stack. PUSH and POP are synonyms for STMDB and LDM (or LDMIA) with the memory addresses for the access based on SP, and with the final address for the access written back to the SP. PUSH and POP are the preferred mnemonics in these cases.

#### Syntax

```
PUSH{cond} reglist
```

```
POP{cond} reglist
```

where:

- ‘*cond*’ is an optional condition code (see [Conditional execution on page 64](#))
- ‘*reglist*’ is a non-empty list of registers (or register ranges), enclosed in braces. Commas must separate register lists or ranges (see [Examples on page 76](#)).

#### Operation

- PUSH stores registers on the stack in order of decreasing register numbers, with the highest numbered register using the highest memory address and the lowest numbered register using the lowest memory address.
- POP loads registers from the stack in order of increasing register numbers, with the lowest numbered register using the lowest memory address and the highest numbered register using the highest memory address.
- PUSH uses the value in the SP register minus four as the highest memory address, POP uses the SP register value as the lowest memory address, implementing a full-descending stack. On completion, PUSH updates the SP register to point to the location of the lowest store value, POP updates the SP register to point to the location above the highest location loaded.
- If a POP instruction includes PC in its reglist, a branch to this location is performed when the POP instruction has completed. Bit[0] of the value read for the PC is used to update the APSR T-bit. This bit must be 1 to ensure correct operation. See [LDM and STM on page 75](#) for more information.

#### Restrictions

In these instructions:

- ‘*reglist*’ must not contain SP
- For the PUSH instruction, *reglist* must not contain PC
- For the POP instruction, *reglist* must not contain PC if it contains LR. When PC is in *reglist* in a POP instruction: bit[0] of the value loaded to the PC must be 1 for correct execution, and a branch occurs to this halfword-aligned address. If the instruction is conditional, it must be the last instruction in the IT block.

#### Condition flags

These instructions do not change the flags.

#### Examples

```
PUSH {R0,R4-R7} ; Push R0,R4,R5,R6,R7 onto the stack
PUSH {R2,LR}   ; Push R2 and the link-register onto the stack
POP  {R0,R6,PC} ; Pop r0,r6 and PC from the stack, then branch to new PC.
```

### 3.4.8 LDREX and STREX

Load and store register exclusive.

#### Syntax

```
LDREX{cond} Rt, [Rn {, #offset}]
STREX{cond} Rd, Rt, [Rn {, #offset}]
LDREXB{cond} Rt, [Rn]
STREXB{cond} Rd, Rt, [Rn]
LDREXH{cond} Rt, [Rn]
STREXH{cond} Rd, Rt, [Rn]
```

where:

- ‘*cond*’ is an optional condition code (see [Conditional execution on page 64](#))
- ‘*Rd*’ is the destination register for the returned status
- ‘*Rt*’ is the register to load or store
- ‘*Rn*’ is the register on which the memory address is based
- ‘*offset*’ is an optional offset applied to the value in *Rn*. If *offset* is omitted, the address is the value in *Rn*.

#### Operation

LDREX, LDREXB, and LDREXH load a word, byte, and halfword respectively from a memory address.

STREX, STREXB, and STREXH attempt to store a word, byte, and halfword respectively to a memory address. The address used in any store-exclusive instruction must be the same as the address in the most recently executed load-exclusive instruction. The value stored by the store-exclusive instruction must also have the same data size as the value loaded by the preceding load-exclusive instruction. This means software must always use a load-exclusive instruction and a matching store-exclusive instruction to perform a synchronization operation, see [Synchronization primitives on page 33](#).

If a store-exclusive instruction performs the store, it writes 0 to its destination register.

If it does not perform the store, it writes 1 to its destination register.

If the store-exclusive instruction writes 0 to the destination register, it is guaranteed that no other process in the system has accessed the memory location between the load-exclusive and store-exclusive instructions.

For reasons of performance, keep the number of instructions between corresponding load-exclusive and store-exclusive instruction to a minimum.

*Note:* *The result of executing a store-exclusive instruction to an address that is different from that used in the preceding load-exclusive instruction is unpredictable.*

## Restrictions

In these instructions:

- Do not use PC
- Do not use SP for *Rd* and *Rt*
- For STREX, *Rd* must be different from both *Rt* and *Rn*
- The value of offset must be a multiple of four in the range 0-1020

## Condition flags

These instructions do not change the flags.

## Examples

```

MOV R1, #0x1                ; initialize the 'lock taken' value try
LDREX R0, [LockAddr]       ; load the lock value
CMP R0, #0                  ; is the lock free?
ITT EQ                      ; IT instruction for STREXEQ and CMPEQ
STREXEQ R0, R1, [LockAddr] ; try and claim the lock
CMPEQ R0, #0                ; did this succeed?
BNE try                     ; no - try again
                            ; yes - we have the lock

```

### 3.4.9 CLREX

Clear exclusive.

#### Syntax

```
CLREX{cond}
```

where:

'*cond*' is an optional condition code (see [Conditional execution on page 64](#))

#### Operation

Use CLREX to make the next STREX, STREXB, or STREXH instruction write 1 to its destination register and fail to perform the store. It is useful in exception handler code to force the failure of the store exclusive if the exception occurs between a load exclusive instruction and the matching store exclusive instruction in a synchronization operation.

See [Synchronization primitives on page 33](#) for more information.

#### Condition flags

These instructions do not change the flags.

#### Examples

```
CLREX
```

### 3.5 General data processing instructions

[Table 28](#) shows the data processing instructions.

**Table 28. Data processing instructions**

Mnemonic	Brief description	See
ADC	Add with carry	<a href="#">ADD, ADC, SUB, SBC, and RSB on page 82</a>
ADD	Add	<a href="#">ADD, ADC, SUB, SBC, and RSB on page 82</a>
ADDW	Add	<a href="#">ADD, ADC, SUB, SBC, and RSB on page 82</a>
AND	Logical AND	<a href="#">AND, ORR, EOR, BIC, and ORN on page 84</a>
ASR	Arithmetic shift right	<a href="#">ASR, LSL, LSR, ROR, and RRX on page 85</a>
BIC	Bit clear	<a href="#">AND, ORR, EOR, BIC, and ORN on page 84</a>
CLZ	Count leading zeros	<a href="#">CLZ on page 86</a>
CMN	Compare negative	<a href="#">CMP and CMN on page 87</a>
CMP	Compare	<a href="#">CMP and CMN on page 87</a>
EOR	Exclusive OR	<a href="#">AND, ORR, EOR, BIC, and ORN on page 84</a>
LSL	Logical shift left	<a href="#">ASR, LSL, LSR, ROR, and RRX on page 85</a>
LSR	Logical shift right	<a href="#">ASR, LSL, LSR, ROR, and RRX on page 85</a>
MOV	Move	<a href="#">MOV and MVN on page 88</a>
MOVT	Move top	<a href="#">MOVT on page 90</a>
MOVW	Move 16-bit constant	<a href="#">MOV and MVN on page 88</a>
MVN	Move NOT	<a href="#">MOV and MVN on page 88</a>
ORN	Logical OR NOT	<a href="#">AND, ORR, EOR, BIC, and ORN on page 84</a>
ORR	Logical OR	<a href="#">AND, ORR, EOR, BIC, and ORN on page 84</a>
RBIT	Reverse bits	<a href="#">REV, REV16, REVSH, and RBIT on page 91</a>
REV	Reverse byte order in a word	<a href="#">REV, REV16, REVSH, and RBIT on page 91</a>
REV16	Reverse byte order in each halfword	<a href="#">REV, REV16, REVSH, and RBIT on page 91</a>
REVSH	Reverse byte order in bottom halfword and sign extend	<a href="#">REV, REV16, REVSH, and RBIT on page 91</a>
ROR	Rotate right	<a href="#">ASR, LSL, LSR, ROR, and RRX on page 85</a>
RRX	Rotate right with extend	<a href="#">ASR, LSL, LSR, ROR, and RRX on page 85</a>
RSB	Reverse subtract	<a href="#">ADD, ADC, SUB, SBC, and RSB on page 82</a>
SADD16	Signed add 16	<a href="#">SADD16 and SADD8 on page 92</a>
SADD8	Signed add 8	<a href="#">SADD16 and SADD8 on page 92</a>
SASX	Signed add and subtract with exchange	<a href="#">SASX and SSAX on page 97</a>
SSAX	Signed subtract and add with exchange	<a href="#">SASX and SSAX on page 97</a>
SBC	Subtract with carry	<a href="#">ADD, ADC, SUB, SBC, and RSB on page 82</a>



Table 28. Data processing instructions (continued)

Mnemonic	Brief description	See
SHADD16	Signed halving add 16	<a href="#">SHADD16 and SHADD8 on page 93</a>
SHADD8	Signed halving add 8	<a href="#">SHADD16 and SHADD8 on page 93</a>
SHASX	Signed halving add and subtract with exchange	<a href="#">SHASX and SHSAX on page 94</a>
SHSAX	Signed halving subtract and add with exchange	<a href="#">SHASX and SHSAX on page 94</a>
SHSUB16	Signed halving subtract 16	<a href="#">SHSUB16 and SHSUB8 on page 95</a>
SHSUB8	Signed halving subtract 8	<a href="#">SHSUB16 and SHSUB8 on page 95</a>
SSUB16	Signed subtract 16	<a href="#">SSUB16 and SSUB8 on page 96</a>
SSUB8	Signed subtract 8	<a href="#">SSUB16 and SSUB8 on page 96</a>
SUB	Subtract	<a href="#">ADD, ADC, SUB, SBC, and RSB on page 82</a>
SUBW	Subtract	<a href="#">ADD, ADC, SUB, SBC, and RSB on page 82</a>
TEQ	Test equivalence	<a href="#">SADD16 and SADD8 on page 92</a>
TST	Test	<a href="#">SADD16 and SADD8 on page 92</a>
UADD16	Unsigned add 16	<a href="#">UADD16 and UADD8 on page 99</a>
UADD8	Unsigned add 8	<a href="#">UADD16 and UADD8 on page 99</a>
UASX	Unsigned add and subtract with exchange	<a href="#">UASX and USAX on page 100</a>
USAX	Unsigned subtract and add with exchange	<a href="#">UASX and USAX on page 100</a>
UHADD16	Unsigned halving add 16	<a href="#">UHADD16 and UHADD8 on page 101</a>
UHADD8	Unsigned halving add 8	<a href="#">UHADD16 and UHADD8 on page 101</a>
UHASX	Unsigned halving add and subtract with exchange	<a href="#">UHASX and UHSAX on page 102</a>
UHSAX	Unsigned halving subtract and add with exchange	<a href="#">UHASX and UHSAX on page 102</a>
UHSUB16	Unsigned halving subtract 16	<a href="#">UHSUB16 and UHSUB8 on page 103</a>
UHSUB8	Unsigned halving subtract 8	<a href="#">UHSUB16 and UHSUB8 on page 103</a>
USAD8	Unsigned sum of absolute differences	<a href="#">USAD8 on page 105</a>
USADA8	Unsigned sum of absolute differences and accumulate	<a href="#">USADA8 on page 106</a>
USUB16	Unsigned subtract 16	<a href="#">USUB16 and USUB8 on page 107</a>
USUB8	Unsigned subtract 8	<a href="#">USUB16 and USUB8 on page 107</a>

### 3.5.1 ADD, ADC, SUB, SBC, and RSB

Add, add with carry, subtract, subtract with carry, and reverse subtract.

#### Syntax

```
op{S}{cond} {Rd,} Rn, Operand2
```

```
op{cond} {Rd,} Rn, #imm12; ADD and SUB only
```

where:

- ‘*op*’ is one of:
  - ADD: Add
  - ADC: Add with carry
  - SUB: Subtract
  - SBC: Subtract with carry
  - RSB: Reverse subtract
- ‘*S*’ is an optional suffix. If *S* is specified, the condition code flags are updated on the result of the operation (see [Conditional execution on page 64](#))
- ‘*cond*’ is an optional condition code (see [Conditional execution on page 64](#))
- ‘*Rd*’ is the destination register. If *Rd* is omitted, the destination register is *Rn*
- ‘*Rn*’ is the register holding the first operand
- ‘*Operand2*’ is a flexible second operand (see [Flexible second operand on page 59](#) for details of the options).
- ‘*imm12*’ is any value in the range 0—4095

#### Operation

The ADD instruction adds the value of *operand2* or *imm12* to the value in *Rn*.

The ADC instruction adds the values in *Rn* and *operand2*, together with the carry flag.

The SUB instruction subtracts the value of *operand2* or *imm12* from the value in *Rn*.

The SBC instruction subtracts the value of *operand2* from the value in *Rn*. If the carry flag is clear, the result is reduced by one.

The RSB instruction subtracts the value in *Rn* from the value of *operand2*. This is useful because of the wide range of options for *operand2*.

Use ADC and SBC to synthesize multiword arithmetic (see [Multiword arithmetic examples on page 83](#) and [ADR on page 69](#)).

ADDW is equivalent to the ADD syntax that uses the *imm12* operand. SUBW is equivalent to the SUB syntax that uses the *imm12* operand.

## Restrictions

In these instructions:

- *Operand2* must be neither SP nor PC
- *Rd* can be SP only in ADD and SUB, and only with the following additional restrictions:
  - *Rn* must also be SP
  - Any shift in operand2 must be limited to a maximum of three bits using LSL
- *Rn* can be SP only in ADD and SUB
- *Rd* can be PC only in the ADD{cond} PC, PC, *Rm* instruction where:
  - You must not specify the S suffix
  - *Rm* must be neither PC nor SP
  - If the instruction is conditional, it must be the last instruction in the IT block
- With the exception of the ADD{cond} PC, PC, *Rm* instruction, *Rn* can be PC only in ADD and SUB, and only with the following additional restrictions:
  - You must not specify the S suffix
  - The second operand must be a constant in the range 0 to 4095

- Note:*
- 1 When using the PC for an addition or a subtraction, bits[1:0] of the PC are rounded to b00 before performing the calculation, making the base address for the calculation word-aligned.
  - 2 If you want to generate the address of an instruction, you have to adjust the constant based on the value of the PC. ARM recommends that you use the ADR instruction instead of ADD or SUB with *Rn* equal to the PC, because your assembler automatically calculates the correct constant for the ADR instruction.

When *Rd* is PC in the ADD{cond} PC, PC, *Rm* instruction:

- Bit[0] of the value written to the PC is ignored
- A branch occurs to the address created by forcing bit[0] of that value to 0

## Condition flags

If S is specified, these instructions update the N, Z, C and V flags according to the result.

## Examples

```
ADD R2, R1, R3
SUBS R8, R6, #240      ; sets the flags on the result
RSB R4, R4, #1280     ; subtracts contents of R4 from 1280
ADCHI R11, R0, R3     ; only executed if C flag set and Z flag clear
```

## Multiword arithmetic examples

*Specific example 4: 64-bit addition* shows two instructions that add a 64-bit integer contained in R2 and R3 to another 64-bit integer contained in R0 and R1, and place the result in R4 and R5.

### Specific example 4: 64-bit addition

```
ADDS R4, R0, R2      ; add the least significant words
ADC R5, R1, R3       ; add the most significant words with carry
```

Multiword values do not have to use consecutive registers. [Specific example 5: 96-bit subtraction](#) shows instructions that subtract a 96-bit integer contained in R9, R1, and R11 from another contained in R6, R2, and R8. The example stores the result in R6, R9, and R2.

### Specific example 5: 96-bit subtraction

```

SUBS R6, R6, R9      ; subtract the least significant words
SBCS R9, R2, R1     ; subtract the middle words with carry
SBC R2, R8, R11     ; subtract the most significant words with carry

```

## 3.5.2 AND, ORR, EOR, BIC, and ORN

Logical AND, OR, exclusive OR, bit clear, and OR NOT.

### Syntax

```
op{S}{cond} {Rd,} Rn, Operand2
```

where:

- 'op' is one of:  
AND: Logical AND  
ORR: Logical OR or bit set  
EOR: Logical exclusive OR  
BIC: Logical AND NOT or bit clear  
ORN: Logical OR NOT
- 'S' is an optional suffix. If S is specified, the condition code flags are updated on the result of the operation (see [Conditional execution on page 64](#)).
- 'cond' is an optional condition code (see [Conditional execution on page 64](#))
- 'Rd' is the destination register
- 'Rn' is the register holding the first operand
- 'Operand2' is a flexible second operand (see [Flexible second operand on page 59](#) for details of the options).

### Operation

The AND, EOR, and ORR instructions perform bitwise AND, exclusive OR, and OR operations on the values in *Rn* and *operand2*.

The BIC instruction performs an AND operation on the bits in *Rn* with the complements of the corresponding bits in the value of *operand2*.

The ORN instruction performs an OR operation on the bits in *Rn* with the complements of the corresponding bits in the value of *operand2*.

### Restrictions

Do not use either SP or PC.

### Condition flags

If S is specified, these instructions:

- Update the N and Z flags according to the result
- Can update the C flag during the calculation of *operand2* (see [Flexible second operand on page 59](#))
- Do not affect the V flag

### Examples

```
AND R9, R2, #0xFF00
ORREQ R2, R0, R5
ANDS R9, R8, #0x19
EORS R7, R11, #0x18181818
BIC R0, R1, #0xab
ORN R7, R11, R14, ROR #4
ORNS R7, R11, R14, ASR #32
```

### 3.5.3 ASR, LSL, LSR, ROR, and RRX

Arithmetic shift right, logical shift left, logical shift right, rotate right, and rotate right with extend.

#### Syntax

```
op{S}{cond} Rd, Rm, Rs
op{S}{cond} Rd, Rm, #n
RRX{S}{cond} Rd, Rm
```

where:

- 'op' is one of:  
ASR: Arithmetic shift right  
LSL: Logical shift left  
LSR: Logical shift right  
ROR: Rotate right
- 'S' is an optional suffix. If S is specified, the condition code flags are updated on the result of the operation (see [Conditional execution on page 64](#))
- 'Rd' is the destination register
- 'Rm' is the register holding the value to be shifted
- 'Rs' is the register holding the shift length to apply to the value *Rm*. Only the least significant byte is used and can be in the range 0 to 255.
- 'n' is the shift length. The range of shift lengths depend on the instruction as follows:  
ASR: Shift length from 1 to 32  
LSL: Shift length from 0 to 31  
LSR: Shift length from 1 to 32  
ROR: Shift length from 1 to 31

*Note:* *MOVS Rd, Rm* is the preferred syntax for *LSLS Rd, Rm, #0*.

### Operation

ASR, LSL, LSR, and ROR move the bits in the register *Rm* to the left or right by the number of places specified by constant *n* or register *Rs*.

RRX moves the bits in register *Rm* to the right by 1.

In all these instructions, the result is written to *Rd*, but the value in register *Rm* remains unchanged. For details on what result is generated by the different instructions (see [Shift operations on page 61](#)).

### Restrictions

Do not use either SP or PC.

### Condition flags

If S is specified:

- These instructions update the N and Z flags according to the result
- The C flag is updated to the last bit shifted out, except when the shift length is 0 (see [Shift operations on page 61](#)).

### Examples

```
ASR R7, R8, #9      ; arithmetic shift right by 9 bits
LSLS R1, R2, #3     ; logical shift left by 3 bits with flag update
LSR R4, R5, #6      ; logical shift right by 6 bits
ROR R4, R5, R6      ; rotate right by the value in the bottom byte of R6
RRX R4, R5          ; rotate right with extend
```

## 3.5.4 CLZ

Count leading zeros.

Syntax

```
CLZ{cond} Rd, Rm
```

where:

- '*cond*' is an optional condition code (see [Conditional execution on page 64](#))
- '*Rd*' is the destination register
- '*Rm*' is the operand register

### Operation

The CLZ instruction counts the number of leading zeros in the value in *Rm* and returns the result in *Rd*. The result value is 32 if no bits are set in the source register, and zero if bit[31] is set.

### Restrictions

Do not use either SP or PC.

### Condition flags

This instruction does not change the flags.

## Examples

```
CLZ R4, R9
CLZNE R2, R3
```

### 3.5.5 CMP and CMN

Compare and compare negative.

#### Syntax

```
CMP{cond} Rn, Operand2
CMN{cond} Rn, Operand2
```

where:

- ‘*cond*’ is an optional condition code (see [Conditional execution on page 64](#))
- ‘*Rn*’ is the register holding the first operand
- ‘*Operand2*’ is a flexible second operand (see [Flexible second operand on page 59](#)) for details of the options.

#### Operation

These instructions compare the value in a register with *operand2*. They update the condition flags on the result, but do not write the result to a register.

The CMP instruction subtracts the value of *operand2* from the value in *Rn*. This is the same as a SUBS instruction, except that the result is discarded.

The CMN instruction adds the value of *operand2* to the value in *Rn*. This is the same as an ADDS instruction, except that the result is discarded.

#### Restrictions

In these instructions:

- Do not use PC
- *Operand2* must not be SP

#### Condition flags

These instructions update the N, Z, C and V flags according to the result.

#### Examples

```
CMP R2, R9
CMN R0, #6400
CMPGT SP, R7, LSL #2
```

### 3.5.6 MOV and MVN

Move and move NOT.

#### Syntax

```
MOV{S}{cond} Rd, Operand2
```

```
MOV{cond} Rd, #imm16
```

```
MVN{S}{cond} Rd, Operand2
```

where:

- 'S' is an optional suffix. If S is specified, the condition code flags are updated on the result of the operation (see [Conditional execution on page 64](#)).
- 'cond' is an optional condition code (see [Conditional execution on page 64](#))
- 'Rd' is the destination register
- 'Operand2' is a flexible second operand (see [Flexible second operand on page 59](#)) for details of the options.
- 'imm16' is any value in the range 0—65535

#### Operation

The MOV instruction copies the value of *operand2* into *Rd*.

When *operand2* in a MOV instruction is a register with a shift other than LSL #0, the preferred syntax is the corresponding shift instruction:

- ASR{S}{cond} Rd, Rm, #n is the preferred syntax for MOV{S}{cond} Rd, Rm, ASR #n
- LSL{S}{cond} Rd, Rm, #n is the preferred syntax for MOV{S}{cond} Rd, Rm, LSL #n if n != 0
- LSR{S}{cond} Rd, Rm, #n is the preferred syntax for MOV{S}{cond} Rd, Rm, LSR #n
- ROR{S}{cond} Rd, Rm, #n is the preferred syntax for MOV{S}{cond} Rd, Rm, ROR #n
- RRX{S}{cond} Rd, Rm is the preferred syntax for MOV{S}{cond} Rd, Rm, RRX

Also, the MOV instruction permits additional forms of *operand2* as synonyms for shift instructions:

- MOV{S}{cond} Rd, Rm, ASR Rs is a synonym for ASR{S}{cond} Rd, Rm, Rs
- MOV{S}{cond} Rd, Rm, LSL Rs is a synonym for LSL{S}{cond} Rd, Rm, Rs
- MOV{S}{cond} Rd, Rm, LSR Rs is a synonym for LSR{S}{cond} Rd, Rm, Rs
- MOV{S}{cond} Rd, Rm, ROR Rs is a synonym for ROR{S}{cond} Rd, Rm, Rs

See [ASR, LSL, LSR, ROR, and RRX on page 85](#).

The MVN instruction takes the value of *operand2*, performs a bitwise logical NOT operation on the value, and places the result into *Rd*.

**Note:** *The MOVW instruction provides the same function as MOV, but is restricted to using the imm16 operand.*



## Restrictions

You can use SP and PC only in the MOV instruction, with the following restrictions:

- The second operand must be a register without shift
- You must not specify the S suffix

When *Rd* is PC in a MOV instruction:

- bit[0] of the value written to the PC is ignored
- A branch occurs to the address created by forcing bit[0] of that value to 0.

*Note:* Though it is possible to use MOV as a branch instruction, ARM strongly recommends the use of a BX or BLX instruction to branch for software portability to the ARM instruction set.

## Condition flags

If S is specified, these instructions:

- Update the N and Z flags according to the result
- Can update the C flag during the calculation of *operand2* (see [Flexible second operand on page 59](#)).
- Do not affect the V flag

## Example

```
MOVS R11, #0x000B    ; write value of 0x000B to R11, flags get updated
MOV R1, #0xFA05     ; write value of 0xFA05 to R1, flags not updated
MOVS R10, R12       ; write value in R12 to R10, flags get updated
MOV R3, #23         ; write value of 23 to R3
MOV R8, SP          ; write value of stack pointer to R8
MVNS R2, #0xF       ; write value of 0xFFFFFFFF0 (bitwise inverse of 0xF)
                    ; to the R2 and update flags
```

### 3.5.7 MOV<sub>T</sub>

Move top.

#### Syntax

```
MOVT{cond} Rd, #imm16
```

where:

- ‘*cond*’ is an optional condition code (see [Conditional execution on page 64](#))
- ‘*Rd*’ is the destination register
- ‘*imm16*’ is a 16-bit immediate constant

#### Operation

MOV<sub>T</sub> writes a 16-bit immediate value, *imm16*, to the top halfword, *Rd*[31:16], of its destination register. The write does not affect *Rd*[15:0].

The MOV, MOV<sub>T</sub> instruction pair enables you to generate any 32-bit constant.

#### Restrictions

*Rd* must be neither SP nor PC.

#### Condition flags

This instruction does not change the flags.

#### Examples

```
MOVT R3, #0xF123      ; write 0xF123 to upper halfword of R3,  
                       ; lower halfword and APSR are unchanged
```

### 3.5.8 REV, REV16, REVSH, and RBIT

Reverse bytes and reverse bits.

#### Syntax

```
op{cond} Rd, Rn
```

where:

- ‘*op*’ is one of:
  - REV: Reverse byte order in a word
  - REV16: Reverse byte order in each halfword independently
  - REVSH: Reverse byte order in the bottom halfword, and sign extends to 32 bits
  - RBIT: Reverse the bit order in a 32-bit word
- ‘*cond*’ is an optional condition code (see [Conditional execution on page 64](#))
- ‘*Rd*’ is the destination register
- ‘*Rn*’ is the register holding the operand

#### Operation

Use these instructions to change endianness of data:

- REV: Converts either:
  - 32-bit big-endian data into little-endian data
  - or 32-bit little-endian data into big-endian data.
- REV16: Converts either:
  - 16-bit big-endian data into little-endian data
  - or 16-bit little-endian data into big-endian data.
- REVSH: Converts either:
  - 16-bit signed big-endian data into 32-bit signed little-endian data
  - 16-bit signed little-endian data into 32-bit signed big-endian data

#### Restrictions

Do not use either SP or PC.

#### Condition flags

These instructions do not change the flags.

#### Examples

```
REV R3, R7 ; reverse byte order of value in R7 and write it to R3
REV16 R0, R0 ; reverse byte order of each 16-bit halfword in R0
REVSH R0, R5 ; reverse Signed Halfword
REVHS R3, R7 ; reverse with Higher or Same condition
RBIT R7, R8 ; reverse bit order of value in R8 and write result to R7
```

### 3.5.9 SADD16 and SADD8

Signed add 16 and Signed add 8

#### Syntax

`op{cond}{Rd,} Rn, Rm`

where:

- `op` is any of:
  - SADD16: Performs two 16-bit signed integer additions.
  - SADD8: Performs four 8-bit signed integer additions.
- '`cond`' is an optional condition code (see [Conditional execution on page 64](#))
- '`Rd`' is the destination register
- '`Rn`' is the register holding the operand
- '`Rm`' is the second register holding the operand.

#### Operation

Use these instructions to perform a halfword or byte add in parallel:

The SADD16 instruction:

1. Adds each halfword from the first operand to the corresponding halfword of the second operand.
2. Writes the result in the corresponding halfwords of the destination register.

The SADD8 instruction:

1. Adds each byte of the first operand to the corresponding byte of the second operand.
2. Writes the result in the corresponding bytes of the destination register.

#### Restrictions

Do not use SP and do not use PC.

#### Condition flags

These instructions do not change the flags.

#### Examples

```
SADD16 R1, R0      ; Adds the halfwords in R0 to the corresponding halfword
                   ; of R1 and writes to corresponding halfword of R1.
SADD8  R4, R0, R5  ; Adds bytes of R0 to the corresponding byte in R5 and
                   ; writes to the corresponding byte in R4.
```

### 3.5.10 SHADD16 and SHADD8

Signed halving add 16 and Signed halving add 8

#### Syntax

```
op{cond}{Rd,} Rn, Rm
```

where:

- op is any of:  
SHADD16: Signed halving add 16  
SHADD8: Signed halving add 8
- 'cond' is an optional condition code (see [Conditional execution on page 64](#))
- 'Rd' is the destination register
- 'Rn' is the register holding the operand
- 'Rm' is the second operand register.

#### Operation

Use these instructions to add 16-bit and 8-bit data and then to halve the result before writing the result to the destination register:

The SHADD16 instruction:

1. Adds each halfword from the first operand to the corresponding halfword of the second operand.
2. Shuffles the result by one bit to the right, halving the data.
3. Writes the halfword results in the destination register.

The SHADD8 instruction:

1. Adds each byte of the first operand to the corresponding byte of the second operand.
2. Shuffles the result by one bit to the right, halving the data.
3. Writes the byte results in the destination register.

#### Restrictions

Do not use SP and do not use PC.

#### Condition flags

These instructions do not change the flags.

#### Examples

```
SHADD16 R1, R0      ; Adds halfwords in R0 to corresponding halfword of R1 &
                   ; writes halved result to corresponding halfword in R1
SHADD8  R4, R0, R5 ; Adds bytes of R0 to corresponding byte in R5 and
                   ; writes halved result to corresponding byte in R4.
```

### 3.5.11 SHASX and SHSAX

Signed halving add and subtract with exchange / Signed halving subtract and add with exchange.

#### Syntax

```
op{cond} {Rd}, Rn, Rm
```

where:

- op is any of:  
SHASX: Add and subtract with exchange and halving.  
SHSAX: Subtract and add with exchange and halving.
- 'cond' is an optional condition code (see [Conditional execution on page 64](#))
- 'Rd' is the destination register
- 'Rn' is the register holding the operand
- 'Rn', 'Rm' are the registers holding the first and second operands

#### Operation

The SHASX instruction:

1. Adds the top halfword of the first operand with the bottom halfword of second operand.
2. Writes the halfword result of the addition to the top halfword of the destination register, shifted by one bit to the right causing a divide by two, or halving.
3. Subtracts the top halfword of second operand from bottom highword of first operand.
4. Writes the halfword result of the division in the bottom halfword of the destination register, shifted by one bit to the right causing a divide by two, or halving.

The SHSAX instruction:

1. Subtracts the bottom halfword of second operand from top highword of first operand.
2. Writes the halfword result of the addition to the bottom halfword of the destination register, shifted by one bit to the right causing a divide by two, or halving.
3. Adds the bottom halfword of the first operand with the top halfword of second operand.
4. Writes the halfword result of the division in the top halfword of the destination register, shifted by one bit to the right causing a divide by two, or halving.

#### Restrictions

Do not use SP and do not use PC.

#### Condition flags

These instructions do not affect the condition code flags.

#### Examples

```
SHASX  R7, R4, R2 ; Adds top halfword of R4 to bottom halfword of R2
          ; and writes halved result to top halfword of R7
          ; Subtracts top halfword of R2 from bottom halfword of
          ; R4 and writes halved result to bottom halfword of R7
SHSAX  R0, R3, R5 ; Subtracts bottom halfword of R5 from top halfword
          ; of R3 and writes halved result to top halfword of R0
```

```

; Adds top halfword of R5 to bottom halfword of R3 and
; writes halved result to bottom halfword of R0.

```

### 3.5.12 SHSUB16 and SHSUB8

Signed halving subtract 16 and Signed halving subtract 8

#### Syntax

```
op{cond}{Rd,} Rn, Rm
```

where:

- op is any of:  
SHSUB16: Signed halving subtract 16  
SHSUB8: Signed halving subtract 8
- 'cond' is an optional condition code (see [Conditional execution on page 64](#))
- 'Rd' is the destination register
- 'Rn' is the register holding the operand
- 'Rm' is the second operand register

#### Operation

Use these instructions to add 16-bit and 8-bit data and then to halve the result before writing the result to the destination register:

The SHSUB16 instruction:

1. Subtracts each halfword of the second operand from the corresponding halfwords of the first operand.
2. Shuffles the result by one bit to the right, halving the data.
3. Writes the halved halfword results in the destination register.

The SHSUB8 instruction:

1. Subtracts each byte of the second operand from the corresponding byte of the first operand,
2. Shuffles the result by one bit to the right, halving the data,
3. Writes the corresponding signed byte results in the destination register.

#### Restrictions

Do not use SP and do not use PC.

#### Condition flags

These instructions do not change the flags.

#### Examples

```

SHSUB16 R1, R0      ; Subtracts halfwords in R0 from corresponding halfword
                    ; of R1 and writes to corresponding halfword of R1
SHSUB8  R4, R0, R5  ; Subtracts bytes of R0 from corresponding byte in R5,
                    ; and writes to corresponding byte in R4.

```

### 3.5.13 SSUB16 and SSUB8

Signed subtract 16 and Signed subtract 8

#### Syntax

`op{cond}{Rd,} Rn, Rm`

where:

- `op` is one of:
  - SSUB16: Performs two 16-bit signed integer subtractions.
  - SSUB8: Performs four 8-bit signed integer subtractions.
- '`cond`' is an optional condition code (see [Conditional execution on page 64](#))
- '`Rd`' is the destination register
- '`Rn`' is the register holding the operand
- '`Rm`' is the second operand register

#### Operation

Use these instructions to change endianness of data:

The SSUB16 instruction:

1. Subtracts each halfword from the second operand from the corresponding halfword of the first operand
2. Writes the difference result of two signed halfwords in the corresponding halfword of the destination register.

The SSUB8 instruction:

1. Subtracts each byte of the second operand from the corresponding byte of the first operand
2. Writes the difference result of four signed bytes in the corresponding byte of the destination register.

#### Restrictions

Do not use SP and do not use PC.

#### Condition flags

These instructions do not change the flags.

#### Examples

```
SSUB16 R1, R0      ; Subtracts halfwords in R0 from corresponding halfword
                  ; of R1 and writes to corresponding halfword of R1
SSUB8  R4, R0, R5  ; Subtracts bytes of R5 from corresponding byte in
                  ; R0, and writes to corresponding byte of R4.
```



### 3.5.14 SASX and SSAX

Signed add and subtract with exchange and Signed subtract and add with exchange.

#### Syntax

```
op{cond} {Rd}, Rm, Rn
```

where:

- op is any of:  
SASX: Signed add and subtract with exchange.  
SSAX: Signed subtract and add with exchange.
- 'cond' is an optional condition code (see [Conditional execution on page 64](#))
- 'Rd' is the destination register
- 'Rn', 'Rm' are the registers holding the first and second operands

#### Operation

The SASX instruction:

1. Adds the signed top halfword of the first operand with the signed bottom halfword of the second operand.
2. Writes the signed result of the addition to the top halfword of the destination register.
3. Subtracts the signed bottom halfword of the second operand from the top signed highword of the first operand.
4. Writes the signed result of the subtraction to the bottom halfword of the destination register.

The SSAX instruction:

1. Subtracts the signed bottom halfword of the second operand from the top signed highword of the first operand.
2. Writes the signed result of the addition to the bottom halfword of the destination register.
3. Adds the signed top halfword of the first operand with the signed bottom halfword of the second operand.
4. Writes the signed result of the subtraction to the top halfword of the destination register.

#### Restrictions

Do not use SP and do not use PC.

#### Condition flags

These instructions do not affect the condition code flags.

#### Examples

```
SASX R0, R4, R5 ; Adds top halfword of R4 to bottom halfword of R5 and
                ; writes to top halfword of R0
                ; Subtracts bottom halfword of R5 from top halfword of R4
                ; and writes to bottom halfword of R0
SSAX R7, R3, R2 ; Subtracts top halfword of R2 from bottom halfword of R3
                ; and writes to bottom halfword of R7
```

```

; Adds top halfword of R3 with bottom halfword of R2 and
; writes to top halfword of R7.

```

### 3.5.15 TST and TEQ

Test bits and test equivalence.

#### Syntax

```
TST{cond} Rn, Operand2
```

```
TEQ{cond} Rn, Operand2
```

where:

- ‘*cond*’ is an optional condition code (see [Conditional execution on page 64](#))
- ‘*Rn*’ is the register holding the first operand
- ‘*Operand2*’ is a flexible second operand (see [Flexible second operand on page 59](#)) for details of the options.

#### Operation

These instructions test the value in a register against *operand2*. They update the condition flags based on the result, but do not write the result to a register.

The TST instruction performs a bitwise AND operation on the value in *Rn* and the value of *operand2*. This is the same as the ANDS instruction, except that it discards the result.

To test whether a bit of *Rn* is 0 or 1, use the TST instruction with an *operand2* constant that has that bit set to 1 and all other bits cleared to 0.

The TEQ instruction performs a bitwise exclusive OR operation on the value in *Rn* and the value of *operand2*. This is the same as the EORS instruction, except that it discards the result.

Use the TEQ instruction to test if two values are equal without affecting the V or C flags.

TEQ is also useful for testing the sign of a value. After the comparison, the N flag is the logical exclusive OR of the sign bits of the two operands.

#### Restrictions

Do not use either SP or PC.

#### Condition flags

These instructions:

- Update the N and Z flags according to the result
- Can update the C flag during the calculation of *operand2* (see [Flexible second operand on page 59](#)).
- Do not affect the V flag

#### Examples

```

TST R0, #0x3F8      ; perform bitwise AND of R0 value to 0x3F8,
                   ; APSR is updated but result is discarded
TEQEQ R10, R9       ; conditionally test if value in R10 is equal to
                   ; value in R9, APSR is updated but result is discarded

```

### 3.5.16 UADD16 and UADD8

Unsigned add 16 and Unsigned add 8

#### Syntax

`op{cond}{Rd,} Rn, Rm`

where:

- `op` is one of:
  - UADD16: Performs two 16-bit unsigned integer additions.
  - UADD8: Performs four 8-bit unsigned integer additions.
- '`cond`' is an optional condition code (see [Conditional execution on page 64](#))
- '`Rd`' is the destination register
- '`Rn`' is the first register holding the operand
- '`Rm`' is the second register holding the operand

#### Operation

Use these instructions to add 16- and 8-bit unsigned data:

The UADD16 instruction:

1. Adds each halfword from the first operand to the corresponding halfword of the second operand.
2. Writes the unsigned result in the corresponding halfwords of the destination register.

The UADD8 instruction:

1. Adds each byte of the first operand to the corresponding byte of the second operand.
2. Writes the unsigned result in the corresponding byte of the destination register.

#### Restrictions

Do not use SP and do not use PC.

#### Condition flags

These instructions do not change the flags.

#### Examples

```
UADD16 R1, R0      ; Adds halfwords in R0 to corresponding halfword of R1,
                  ; writes to corresponding halfword of R1
UADD8  R4, R0, R5  ; Adds bytes of R0 to corresponding byte in R5 and writes
                  ; to corresponding byte in R4.
```

### 3.5.17 UASX and USAX

Add and subtract with exchange and Subtract and add with exchange.

#### Syntax

```
op{cond} {Rd}, Rn, Rm
```

where:

- op is one of:  
UASX: Add and subtract with exchange.  
USAX: Subtract and add with exchange.
- 'cond' is an optional condition code (see [Conditional execution on page 64](#))
- 'Rd' is the destination register
- 'Rn' 'Rm' are registers holding the first and second operands

#### Operation

The UASX instruction:

1. Subtracts the top halfword of the second operand from the bottom halfword of the first operand.
2. Writes the unsigned result from the subtraction to the bottom halfword of the destination register.
3. Adds the top halfword of the first operand with bottom halfword of the second operand.
4. Writes the unsigned result of the addition to the top halfword of the destination register.

The USAX instruction:

1. Adds the bottom halfword of the first operand with the top halfword of the second operand.
2. Writes the unsigned result of the addition to the bottom halfword of the destination register.
3. Subtracts the bottom halfword of the second operand from the top halfword of the first operand.
4. Writes the unsigned result from the subtraction to the top halfword of the destination register.

#### Restrictions

Do not use SP and do not use PC.

#### Condition flags

These instructions do not affect the condition code flags.

#### Examples

```
UASX R0, R4, R5 ; Adds top halfword of R4 to bottom halfword of R5 and
                ; writes to top halfword of R0
                ; Subtracts bottom halfword of R5 from top halfword of R0
                ; and writes to bottom halfword of R0
USAX R7, R3, R2 ; Subtracts top halfword of R2 from bottom halfword of R3
                ; and writes to bottom halfword of R7
```

```

; Adds top halfword of R3 to bottom halfword of R2 and
; writes to top halfword of R7.

```

### 3.5.18 UHADD16 and UHADD8

Unsigned halving add 16 and Unsigned halving add 8

#### Syntax

```
op{cond}{Rd,} Rn, Rm
```

where:

- op is any of:  
UHADD16: Unsigned halving add 16.  
UHADD8: Unsigned halving add 8.
- 'cond' is an optional condition code (see [Conditional execution on page 64](#))
- 'Rd' is the destination register
- 'Rn' is the register holding the first operand
- 'Rm' is the register holding the second operand

#### Operation

Use these instructions to add 16- and 8-bit data and then to halve the result before writing the result to the destination register:

The UHADD16 instruction:

1. Adds each halfword from the first operand to the corresponding halfword of the second operand.
2. Shuffles the halfword result by one bit to the right, halving the data.
3. Writes the unsigned results to the corresponding halfword in the destination register.

The UHADD8 instruction:

1. Adds each byte of the first operand to the corresponding byte of the second operand.
2. Shuffles the byte result by one bit to the right, halving the data.
3. Writes the unsigned results in the corresponding byte in the destination register.

#### Restrictions

Do not use SP and do not use PC.

#### Condition flags

These instructions do not change the flags.

#### Examples

```

UHADD16 R7, R3      ; Adds halfwords in R7 to corresponding halfword of R3 &
                    ; writes halved result to corresponding halfword in R7
UHADD8  R4, R0, R5  ; Adds bytes of R0 to corresponding byte in R5 and writes
                    ; halved result to corresponding byte in R4.

```

### 3.5.19 UHASX and UHSAX

Unsigned halving add and subtract with exchange and Unsigned halving subtract and add with exchange.

#### Syntax

`op{cond} {Rd}, Rn, Rm`

where:

- `op` is one of:  
   UHASX: Add and subtract with exchange and halving.  
   UHSAX: Subtract and add with exchange and halving.
- '`cond`' is an optional condition code (see [Conditional execution on page 64](#))
- '`Rd`' is the destination register
- '`Rn`' '`Rm`' are registers holding the first and second operands

#### Operation

The UHASX instruction:

1. Adds the top halfword of the first operand with the bottom halfword of second operand.
2. Shifts the result by one bit to the right causing a divide by two, or halving.
3. Writes the halfword result of the addition to the top halfword of the destination register.
4. Subtracts top halfword of second operand from bottom highword of the first operand.
5. Shifts the result by one bit to the right causing a divide by two, or halving.
6. Writes halfword result of the division in the bottom halfword of the destination register.

The UHSAX instruction:

1. Subtracts the bottom halfword of second operand from top highword of first operand.
2. Shifts the result by one bit to the right causing a divide by two, or halving.
3. Writes halfword result of the subtraction in the top halfword of the destination register.
4. Adds the bottom halfword of the first operand with the top halfword of second operand.
5. Shifts the result by one bit to the right causing a divide by two, or halving.
6. Writes halfword result of the addition to the bottom halfword of the destination register.

#### Restrictions

Do not use SP and do not use PC.

#### Condition flags

These instructions do not affect the condition code flags.

#### Examples

```
UHASX  R7, R4, R2    ; Adds top halfword of R4 with bottom halfword of R2
                        ; and writes halved result to top halfword of R7
                        ; Subtracts top halfword of R2 from bottom halfword of
                        ; R7 and writes halved result to bottom halfword of R7
UHSAX  R0, R3, R5    ; Subtracts bottom halfword of R5 from top halfword of
                        ; R3 and writes halved result to top halfword of R0
```

```

; Adds top halfword of R5 to bottom halfword of R3 and
; writes halved result to bottom halfword of R0.

```

### 3.5.20 UHSUB16 and UHSUB8

Unsigned halving subtract 16 and Unsigned halving subtract 8

#### Syntax

```
op{cond}{Rd,} Rn, Rm
```

where:

- op is any of:  
 UHSUB16: Performs two unsigned 16-bit integer additions, halves the results, and writes the results to the destination register.  
 UHSUB8: Performs four unsigned 8-bit integer additions, halves the results, and writes the results to the destination register.
- 'cond' is an optional condition code (see [Conditional execution on page 64](#))
- 'Rd' is the destination register
- 'Rn' is the first register holding the operand
- 'Rm' is the second register holding the operand

#### Operation

Use these instructions to add 16-bit and 8-bit data and then to halve the result before writing the result to the destination register:

The UHSUB16 instruction:

1. Subtracts each halfword of the second operand from the corresponding halfword of the first operand.
2. Shuffles each halfword result to the right by one bit, halving the data.
3. Writes each unsigned halfword result to corresponding halfword in destination register.

The UHSUB8 instruction:

1. Subtracts each byte of second operand from the corresponding byte of the first operand.
2. Shuffles each byte result by one bit to the right, halving the data.
3. Writes the unsigned byte results to the corresponding byte of the destination register.

#### Restrictions

Do not use SP and do not use PC.

#### Condition flags

These instructions do not change the flags.

#### Examples

```

UHSUB16 R1, R0 ; Subtracts halfwords in R0 from corresponding R1 halfword
                ; and writes halved result to corresponding halfword in R1
UHSUB8  R4, R0, R5 ; Subtracts bytes of R5 from corresponding byte in R0 and
                ; writes halved result to corresponding byte in R4.

```

### 3.5.21 SEL

Select bytes. Selects each byte of its result from either its first operand or its second operand, according to the values of the GE flags.

#### Syntax

```
SEL{<c>}{<q>} {<Rd>}, <Rn>, <Rm>
```

where:

- <c>, <q> are standard assembler syntax fields.
- <Rd> is the destination register.
- <Rn> is the first operand register.
- <Rm> is the second operand register.

#### Operation

The SEL instruction:

1. Reads the value of each bit of APSR.GE.
2. Depending on the value of APSR.GE, assigns the destination register the value of either the first or second operand register.

#### Restrictions

None.

#### Condition flags

These instructions do not change the flags.

#### Examples

```
SADD16 R0, R1, R2 ; Set GE bits based on result  
SEL R0, R0, R3 ; Select bytes from R0 or R3, based on GE.
```



### 3.5.22 USAD8

Unsigned sum of absolute differences

#### Syntax

```
USAD8{cond}{Rd,} Rn, Rm
```

where:

- ‘*cond*’ is an optional condition code (see [Conditional execution on page 64](#))
- ‘*Rd*’ is the destination register
- ‘*Rn*’ is the first operand register
- ‘*Rm*’ is the second operand register

#### Operation

The USAD8 instruction:

1. Subtracts each byte of the second operand register from the corresponding byte of the first operand register.
2. Adds the absolute values of the differences together.
3. Writes the result to the destination register.

#### Restrictions

Do not use SP and do not use PC.

#### Condition flags

These instructions do not change the flags.

#### Examples

```
USAD8 R1, R4, R0      ; Subtracts each byte in R0 from corresponding byte of
                       ; R4 adds the differences and writes to R1
USAD8 R0, R5          ; Subtracts bytes of R5 from corresponding byte in R0,
                       ; adds the differences and writes to R0.
```

### 3.5.23 USADA8

Unsigned sum of absolute differences and accumulate

#### Syntax

```
USADA8{cond}{Rd,} Rn, Rm, Ra
```

where:

- ‘*cond*’ is an optional condition code (see [Conditional execution on page 64](#))
- ‘*Rd*’ is the destination register
- ‘*Rn*’ is the first operand register
- ‘*Rm*’ is the second operand register
- ‘*Ra*’ is the register that contains the accumulation value.

#### Operation

The USADA8 instruction:

1. Subtracts each byte of the second operand register from the corresponding byte of the first operand register.
2. Adds the unsigned absolute differences together.
3. Adds the accumulation value to the sum of the absolute differences.
4. Writes the result to the destination register.

#### Restrictions

Do not use SP and do not use PC.

#### Condition flags

These instructions do not change the flags.

#### Examples

```
USADA8 R1, R0, R6 ; Subtracts bytes in R0 from corresponding halfword of R1
                  ; adds differences, adds value of R6, writes to R1
USADA8 R4, R0, R5, R2 ; Subtracts bytes of R5 from corresponding byte in R0
                  ; adds differences, adds value of R2 writes to R4.
```

### 3.5.24 USUB16 and USUB8

Unsigned subtract 16 and Unsigned subtract 8

#### Syntax

`op{cond}{Rd,} Rn, Rm`

where:

- `op` is any of:
  - USUB16: Unsigned Subtract 16.
  - USUB8: Unsigned Subtract 8.
- '`cond`' is an optional condition code (see [Conditional execution on page 64](#))
- '`Rd`' is the destination register
- '`Rn`' is the register holding the operand
- '`Rm`' is the second operand register

#### Operation

Use these instructions to subtract 16-bit and 8-bit data before writing the result to the destination register:

The USUB16 instruction:

1. Subtracts each halfword from the second operand register from the corresponding halfword of the first operand register.
2. Writes the unsigned result in the corresponding halfwords of the destination register.

The USUB8 instruction:

1. Subtracts each byte of the second operand register from the corresponding byte of the first operand register.
2. Writes the unsigned byte result in the corresponding byte of the destination register.

#### Restrictions

Do not use SP or PC.

#### Condition flags

These instructions do not change the flags.

#### Examples

```
USUB16 R1, R0 ; Subtracts halfwords in R0 from corresponding halfword of  
              ; R1 and writes to corresponding halfword in R1
```

```
USUB8 R4, R0, R5 ; Subtracts bytes of R5 from corresponding byte in R0 and  
                 ; writes to the corresponding byte in R4.
```

### 3.6 Multiply and divide instructions

Table 29 shows the multiply and divide instructions.

**Table 29. Multiply and divide instructions**

Mnemonic	Brief description	See
MLA	Multiply with accumulate, 32-bit result	<a href="#">MUL, MLA, and MLS on page 109</a>
MLS	Multiply and subtract, 32-bit result	<a href="#">MUL, MLA, and MLS on page 109</a>
MUL	Multiply, 32-bit result	<a href="#">MUL, MLA, and MLS on page 109</a>
SDIV	Signed divide	<a href="#">SDIV and UDIV on page 123</a>
SMLA[B,T]	Signed multiply accumulate (halfwords)	<a href="#">SMLA and SMLAW on page 111</a>
SMLAD, SMLADX	Signed multiply accumulate dual	<a href="#">SMLAD on page 113</a>
SMLAL	Signed multiply with accumulate (32x32+64), 64-bit result	<a href="#">SMLAL and SMLALD on page 114</a>
SMLAL[B,T]	Signed multiply accumulate long (halfwords)	<a href="#">SMLAL and SMLALD on page 114</a>
SMLALD, SMLALDX	Signed multiply accumulate long dual	<a href="#">SMLAL and SMLALD on page 114</a>
SMLAW[B T]	Signed multiply accumulate (word by halfword)	<a href="#">SMLA and SMLAW on page 111</a>
SMLSD	Signed multiply subtract dual	<a href="#">SMLSD and SMLSXD on page 116</a>
SMLSXD	Signed multiply subtract long dual	<a href="#">SMLSD and SMLSXD on page 116</a>
SMMLA	Signed most significant word multiply accumulate	<a href="#">SMMLA and SMMLS on page 118</a>
SMMLS, SMMLSR	Signed most significant word multiply subtract	<a href="#">SMMLA and SMMLS on page 118</a>
SMUAD, SMUADX	Signed dual multiply add	<a href="#">SMUAD and SMUSD on page 120</a>
SMUL[B,T]	Signed multiply (word by halfword)	<a href="#">SMUL and SMULW on page 121</a>
SMMUL, SMMULR	Signed most significant word multiply	<a href="#">SMMUL on page 119</a>
SMULL	Signed multiply (32x32), 64-bit result	<a href="#">SMMUL on page 119</a>
SMULWB, SMULWT	Signed multiply (word by halfword)	<a href="#">SMUL and SMULW on page 121</a>
SMUSD, SMUSDX	Signed dual multiply subtract	<a href="#">SMUAD and SMUSD on page 120</a>
UDIV	Unsigned divide	<a href="#">SMLA and SMLAW on page 111</a>
UMAAL	Unsigned multiply accumulate accumulate Long (32x32+32+32), 64-bit result	<a href="#">UMULL, UMAAL and UMLAL on page 110</a>
UMLAL	Unsigned multiply with accumulate (32x32+64), 64-bit result	<a href="#">UMULL, UMAAL and UMLAL on page 110</a>
UMULL	Unsigned multiply (32x32), 64-bit result	<a href="#">UMULL, UMAAL and UMLAL on page 110</a>

### 3.6.1 MUL, MLA, and MLS

Multiply, multiply with accumulate, and multiply with subtract, using 32-bit operands, and producing a 32-bit result.

#### Syntax

```
MUL{S}{cond} {Rd,} Rn, Rm ; Multiply
MLA{cond} Rd, Rn, Rm, Ra ; Multiply with accumulate
MLS{cond} Rd, Rn, Rm, Ra ; Multiply with subtract
```

where:

- '*cond*' is an optional condition code (see [Conditional execution on page 64](#))
- '*S*' is an optional suffix. If *S* is specified, the condition code flags are updated on the result of the operation (see [Conditional execution on page 64](#)).
- '*Rd*' is the destination register. If *Rd* is omitted, the destination register is *Rn*
- '*Rn*', '*Rm*' are registers holding the values to be multiplied
- '*Ra*' is a register holding the value to be added to or subtracted from

#### Operation

The MUL instruction multiplies the values from *Rn* and *Rm*, and places the least significant 32 bits of the result in *Rd*.

The MLA instruction multiplies the values from *Rn* and *Rm*, adds the value from *Ra*, and places the least significant 32 bits of the result in *Rd*.

The MLS instruction multiplies the values from *Rn* and *Rm*, subtracts the product from the value from *Ra*, and places the least significant 32 bits of the result in *Rd*.

The results do not depend on whether the operands are signed or unsigned.

#### Restrictions

In these instructions, do not use SP and do not use PC.

If you use the S suffix with the MUL instruction:

- *Rd*, *Rn*, and *Rm* must all be in the range R0 to R7
- *Rd* must be the same as *Rm*
- You must not use the *cond* suffix

#### Condition flags

If S is specified, the MUL instruction:

- Updates the N and Z flags according to the result
- Does not affect the C and V flags

#### Examples

```
MUL R10, R2, R5 ; multiply, R10 = R2 x R5
MLA R10, R2, R1, R5 ; multiply with accumulate, R10 = (R2 x R1) + R5
MULS R0, R2, R2 ; multiply with flag update, R0 = R2 x R2
MULLT R2, R3, R2 ; conditionally multiply, R2 = R3 x R2
MLS R4, R5, R6, R7 ; multiply with subtract, R4 = R7 - (R5 x R6)
```

### 3.6.2 UMULL, UMAAL and UMLAL

Unsigned long multiply, with optional accumulate, 32-bit operands, producing a 64-bit result.

#### Syntax

```
op{cond} RdLo, RdHi, Rn, Rm
```

where:

- 'op' is one of:  
 UMULL: Unsigned long multiply  
 UMAAL: Unsigned long multiply, with accumulate accumulate  
 UMLAL: Unsigned long multiply, with accumulate
- 'cond' is an optional condition code (see [Conditional execution on page 64](#))
- 'RdHi, RdLo' are the destination registers. They also hold the accumulating value.
- 'Rn, Rm' are registers holding the first and second operands

#### Operation

The UMULL instruction:

1. Multiplies the two unsigned integers in the first and second operands.
2. Writes the least significant 32 bits of the result in *RdLo*.
3. Writes the most significant 32 bits of the result in *RdHi*.

The UMAAL instruction:

1. Multiplies the two unsigned 32-bit integers in the first and second operands.
2. Adds the unsigned 32-bit integer in *RdHi* to the 64-bit result of the multiplication.
3. Adds the unsigned 32-bit integer in *RdLo* to the 64-bit result of the addition.
4. Writes the top 32-bits of the result to *RdHi*.
5. Writes the lower 32-bits of the result to *RdLo*.

The UMLAL instruction:

1. Multiplies the two unsigned integers in the first and second operands.
2. Adds the 64-bit result to the 64-bit unsigned integer contained in *RdHi* and *RdLo*.
3. Writes the result back to *RdHi* and *RdLo*.

#### Restrictions

In these instructions:

- Do not use either SP or PC
- *RdHi* and *RdLo* must be different registers

#### Condition flags

These instructions do not affect the condition code flags.

#### Examples

```
UMULL   R0, R4, R5, R6 ; Multiplies R5 and R6, writes the top 32 bits to R4
                          ; and the bottom 32 bits to R0
UMAAL   R3, R6, R2, R7 ; Multiplies R2 and R7, adds R6, adds R3, writes the
                          ; top 32 bits to R6, and the bottom 32 bits to R3
```

UMLAL R2, R1, R3, R5 ; Multiplies R5 and R3, adds R1:R2, writes to R1:R2.

### 3.6.3 SMLA and SMLAW

Signed multiply accumulate (halfwords).

Syntax

op{XY}{cond} Rd, Rn, Rm

op{Y}{cond} Rd, Rn, Rm, Ra

where

- op is one of:
  - SMLA: Signed multiply accumulate long (halfwords). X and Y specifies which half of the source registers *Rn* and *Rm* are used as the first and second multiply operand.
    - If X is B, then the bottom halfword, bits [15:0], of *Rn* is used.
    - If X is T, then the top halfword, bits [31:16], of *Rn* is used.
    - If Y is B, then the bottom halfword, bits [15:0], of *Rm* is used.
    - If Y is T, then the top halfword, bits [31:16], of *Rm* is used.
  - SMLAW: Signed multiply accumulate (word by halfword). Y specifies which half of the source register *Rm* is used as the second multiply operand.
    - If Y is T, then the top halfword, bits [31:16] of *Rm* is used.
    - If Y is B, then the bottom halfword, bits [15:0] of *Rm* is used.
- ‘cond’ is an optional condition code (see [Conditional execution on page 64](#))
- ‘Rd’ is the destination register. If *Rd* is omitted, the destination register is *Rn*
- ‘Rn’, ‘Rm’ are registers holding the values to be multiplied
- ‘Ra’ is a register holding the value to be added to or subtracted from

Operation

The SMALBB, SMLABT, SMLATB, SMLATT instructions:

1. Multiply the specified signed halfword, top or bottom, values from *Rn* and *Rm*.
2. Add the value in *Ra* to the resulting 32-bit product.
3. Write the result of the multiplication and addition in *Rd*.
4. The non-specified halfwords of the source registers are ignored.

The SMLAWB and SMLAWT instructions:

1. Multiply the 32-bit signed values in *Rn* with:
  - a) The top signed halfword of *Rm*, T instruction suffix.
  - b) The bottom signed halfword of *Rm*, B instruction suffix.
2. Add the 32-bit signed value in *Ra* to the top 32 bits of the 48-bit product
3. Write the result of the multiplication and addition in *Rd*.
4. The bottom 16 bits of the 48-bit product are ignored.
5. If overflow occurs during the addition of the accumulate value, the instruction sets the Q flag in the APSR. No overflow can occur during the multiplication.

Restrictions

In these instructions, do not use SP or PC.

Condition flags

If an overflow is detected, the Q flag is set.

#### Examples

```
SMLABB R5, R6, R4, R1 ; Multiplies bottom halfwords of R6 and R4, adds
                ; R1 and writes to R5
SMLATB R5, R6, R4, R1 ; Multiplies top halfword of R6 with bottom halfword
                ; of R4, adds R1 and writes to R5
SMLATT R5, R6, R4, R1 ; Multiplies top halfwords of R6 and R4, adds
                ; R1 and writes the sum to R5
SMLABT R5, R6, R4, R1 ; Multiplies bottom halfword of R6 with top halfword
                ; of R4, adds R1 and writes to R5
SMLABT R4, R3, R2      ; Multiplies bottom halfword of R4 with top halfword
                ; of R3, adds R2 and writes to R4
SMLAWB R10, R2, R5, R3 ; Multiplies R2 with bottom halfword of R5, adds
                ; R3 to the result and writes top 32-bits to R10
SMLAWT R10, R2, R1, R5 ; Multiplies R2 with top halfword of R1, adds R5
                ; and writes top 32-bits to R10.
```



### 3.6.4 SMLAD

Signed multiply accumulate long dual

Syntax

```
op{X}{cond} Rd, Rn, Rm, Ra ;
```

where:

- op is one of:
  - SMLAD: Signed multiply accumulate dual
  - SMLADX: Signed multiply accumulate dual reverse. X specifies which halfword of the source register *Rn* is used as the multiply operand.
  - If X is omitted, the multiplications are bottom × bottom and top × top.
  - If X is present, the multiplications are bottom × top and top × bottom.
- ‘cond’ is an optional condition code (see [Conditional execution on page 64](#))
- ‘Rd’ is the destination register.
- ‘Rn’ is the first operand register holding the values to be multiplied
- ‘Rm’ is the second operand register
- ‘Ra’ is the accumulate value

Operation

The SMLAD and SMLADX instructions regard the two operands as four halfword 16-bit values. The SMLAD and SMLADX instructions:

1. Either:
  - a) If X is not present, multiply the top signed halfword value in *Rn* with the top signed halfword of *Rm* and the bottom signed halfword values in *Rn* with the bottom signed halfword of *Rm*.
  - a) If X is present, multiply the top signed halfword value in *Rn* with the bottom signed halfword of *Rm* and the bottom signed halfword values in *Rn* with the top signed halfword of *Rm*.
2. Add both multiplication results to the signed 32-bit value in *Ra*.
3. Write the 32-bit signed result of the multiplication and addition to *Rd*.

Restrictions

Do not use SP or PC.

Condition flags

These instructions do not change the flags.

Examples

```
SMLAD R10, R2, R1, R5 ; Multiplies two halfword values in R2 with
                        ; corresponding halfwords in R1, adds R5 and writes
                        ; to R10
```

```
SMLALDX R0, R2, R4, R6 ; Multiplies top halfword of R2 with bottom halfword
                        ; of R4, multiplies bottom halfword of R2 with top
                        ; halfword of R4, adds R6 and writes to R0.
```

### 3.6.5 SMLAL and SMLALD

Signed multiply accumulate long, signed multiply accumulate long (halfwords) and signed multiply accumulate long dual.

Syntax

`op{cond} RdLo, RdHi, Rn, Rm`

`op{XY}{cond} RdLo, RdHi, Rn, Rm`

`op{X}{cond} RdLo, RdHi, Rn, Rm`

where:

- `op` is one of:
  - SMLAL: Signed multiply accumulate long
  - SMLAL: Signed multiply accumulate long (halfwords, X and Y). X and Y specify which halfword of the source registers *Rn* and *Rm* are used as the first and second multiply operand:
    - If X is B, then the bottom halfword, bits [15:0], of *Rn* is used.
    - If X is T, then the top halfword, bits [31:16], of *Rn* is used.
    - If Y is B, then the bottom halfword, bits [15:0], of *Rm* is used.
    - If Y is T, then the top halfword, bits [31:16], of *Rm* is used.
  - SMLALD: Signed multiply accumulate long Dual
  - SMLALDX: Signed multiply accumulate long dual reversed
    - If the X is omitted, the multiplications are bottom × bottom and top × top.
    - If X is present, the multiplications are bottom × top and top × bottom.
- '`cond`' is an optional condition code (see [Conditional execution on page 64](#))
- '`RdHi`, `RdLo`' are the destination registers. `RdLo` is the lower 32 bits and `RdHi` is the upper 32 bits of the 64-bit integer. For SMLAL, SMLALBB, SMLALBT, SMLALTB, SMLALTT, SMLALD and SMLALDX, they also hold the accumulating value.
- '`Rn`', '`Rm`' are registers holding the first and second operands

Operation

The SMLAL instruction:

1. Multiplies the two's complement signed word values from *Rn* and *Rm*.
2. Adds the 64-bit value in `RdLo` and `RdHi` to the resulting 64-bit product.
3. Writes the 64-bit result of the multiplication and addition in `RdLo` and `RdHi`.

The SMLALBB, SMLALBT, SMLALTB and SMLALTT instructions:

1. Multiplies the specified signed halfword, top or bottom, values from *Rn* and *Rm*.
2. Adds the resulting sign-extended 32-bit product to the 64-bit value in `RdLo` and `RdHi`.
3. Writes the 64-bit result of the multiplication and addition in `RdLo` and `RdHi`.

The non-specified halfwords of the source registers are ignored.

The SMLALD and SMLALDX instructions interpret the values from *Rn* and *Rm* as four halfword two's complement signed 16-bit integers. These instructions:

- If *X* is not present, multiply the top signed halfword value of *Rn* with the top signed halfword of *Rm* and the bottom signed halfword values of *Rn* with the bottom signed halfword of *Rm*.
- Or if *X* is present, multiply the top signed halfword value of *Rn* with the bottom signed halfword of *Rm* and the bottom signed halfword values of *Rn* with the top signed halfword of *Rm*.
- Add the two multiplication results to the signed 64-bit value in *RdLo* and *RdHi* to create the resulting 64-bit product.
- Write the 64-bit product in *RdLo* and *RdHi*.

#### Restrictions

In these instructions:

Do not use *SP* and do not use *PC*.

*RdHi* and *RdLo* must be different registers.

#### Condition flags

These instructions do not affect the condition code flags.

#### Examples

```
SMLAL  R4, R5, R3, R8 ; Multiplies R3 and R8, adds R5:R4 and writes to
                        ; R5:R4
SMLALBT R2, R1, R6, R7 ; Multiplies bottom halfword of R6 with top
                        ; halfword of R7, sign extends to 32-bit, adds
                        ; R1:R2 and writes to R1:R2
SMLALTB R2, R1, R6, R7 ; Multiplies top halfword of R6 with bottom
                        ; halfword of R7, sign extends to 32-bit, adds R1:R2
                        ; and writes to R1:R2
SMLALD  R6, R8, R5, R1 ; Multiplies top halfwords in R5 and R1 and bottom
                        ; halfwords of R5 and R1, adds R8:R6 and writes to
                        ; R8:R6
SMLALDX R6, R8, R5, R1 ; Multiplies top halfword in R5 with bottom
                        ; halfword of R1, and bottom halfword of R5 with
                        ; top halfword of R1, adds R8:R6 and writes to
                        ; R8:R6.
```

### 3.6.6 SMLSD and SMLS LD

Signed multiply subtract dual and Signed multiply subtract long dual

Syntax

`op{X}{cond} Rd, Rn, Rm, Ra`

where:

- `op` is one of:
  - SMLSD: Signed multiply subtract dual.
  - SMLS DX: Signed multiply subtract dual reversed
  - SMLS LD: Signed multiply subtract long dual.
  - SMLS LD X: Signed multiply subtract long dual reversed.
  - If `X` is present, the multiplications are bottom  $\times$  top and top  $\times$  bottom.
  - If the `X` is omitted, the multiplications are bottom  $\times$  bottom and top  $\times$  top.
- '`cond`' is an optional condition code (see [Conditional execution on page 64](#))
- '`Rd`' is the destination register.
- '`Rn`', '`Rm`' are registers holding the first and second operands
- '`Ra`' is the register holding the accumulate value

Operation

The SMLSD instruction interprets the values from the first and second operands as four signed halfwords. This instruction:

1. Optionally rotates the halfwords of the second operand.
2. Performs two signed 16  $\times$  16-bit halfword multiplications.
3. Subtracts the result of the upper halfword multiplication from the result of the lower halfword multiplication.
4. Adds the signed accumulate value to the result of the subtraction.
5. Writes the result of the addition to the destination register.

The SMLS LD instruction interprets the values from `Rn` and `Rm` as four signed halfwords.

This instruction:

1. Optionally rotates the halfwords of the second operand.
2. Performs two signed 16  $\times$  16-bit halfword multiplications.
3. Subtracts the result of the upper halfword multiplication from the result of the lower halfword multiplication.
4. Adds the 64-bit value in `RdHi` and `RdLo` to the result of the subtraction.
5. Writes the 64-bit result of the addition to the `RdHi` and `RdLo`.

Restrictions

In these instructions: Do not use SP or PC.

Condition flags

This instruction sets the Q flag if the accumulate operation overflows. Overflow cannot occur during the multiplications or subtraction.

For the Thumb instruction set, these instructions do not affect the condition code flags.

Examples

SMLS R0, R4, R5, R6 ; Multiplies bottom halfword of R4 with bottom  
; halfword of R5, multiplies top halfword of R4  
; with top halfword of R5, subtracts second from  
; first, adds R6, writes to R0

SMLS DX R1, R3, R2, R0 ; Multiplies bottom halfword of R3 with top  
; halfword of R2, multiplies top halfword of R3  
; with bottom halfword of R2, subtracts second from  
; first, adds R0, writes to R1

SMLS LD R3, R6, R2, R7 ; Multiplies bottom halfword of R6 with bottom  
; halfword of R2, multiplies top halfword of R6  
; with top halfword of R2, subtracts second from  
; first, adds R6:R3, writes to R6:R3

SMLS LD X R3, R6, R2, R7 ; Multiplies bottom halfword of R6 with top  
; halfword of R2, multiplies top halfword of R6  
; with bottom halfword of R2, subtracts second from  
; first, adds R6:R3, writes to R6:R3.

### 3.6.7 SMMLA and SMMLS

Signed most significant word multiply accumulate / multiply subtract

Syntax

`op{R}{cond} Rd, Rn, Rm, Ra`

where:

- `op` is one of:  
   SMMLA: Signed most significant word multiply accumulate.  
   SMMLS: Signed most significant word multiply subtract.
- `R` is a rounding error flag. If `R` is specified, the result is rounded instead of being truncated, 0x80000000 is added to the product before the high word is extracted.
- '`cond`' is an optional condition code (see [Conditional execution on page 64](#))
- '`Rd`' is the destination register.
- '`Rn`', '`Rm`' are registers holding the first and second multiply operands
- '`Ra`' is the register holding the accumulate value

Operation

The SMMLA instruction interprets the values from `Rn` and `Rm` as signed 32-bit words:

1. Multiplies the values in `Rn` and `Rm`.
2. Optionally rounds the result by adding 0x80000000.
3. Extracts the most significant 32 bits of the result.
4. Adds the value of `Ra` to the signed extracted value.
5. Writes the result of the addition in `Rd`.

The SMMLS instruction interprets the values from `Rn` and `Rm` as signed 32-bit words:

1. Multiplies the values in `Rn` and `Rm`.
2. Optionally rounds the result by adding 0x80000000.
3. Extracts the most significant 32 bits of the result.
4. Subtracts the extracted value of the result from the value in `Ra`.
5. Writes the result of the subtraction in `Rd`.

Restrictions

In these instructions: Do not use SP or PC.

Condition flags

These instructions do not affect the condition code flags.

Examples

```
SMMLA   R0, R4, R5, R6   ; Multiplies R4 and R5, extracts top 32 bits,
                        ; adds R6, truncates and writes to R0
SMMLAR  R6, R2, R1, R4   ; Multiplies R2 and R1, extracts top 32 bits,
                        ; adds R4, rounds and writes to R6
SMMLSR  R3, R6, R2, R7   ; Multiplies R6 and R2, extracts top 32 bits,
                        ; subtracts R7, rounds and writes to R3
SMMLS   R4, R5, R3, R8   ; Multiplies R5 and R3, extracts top 32 bits,
                        ; subtracts R8, truncates and writes to R4.
```

### 3.6.8 SMMUL

Signed most significant word multiply

Syntax

```
op{R}{cond} Rd, Rn, Rm
```

where:

- op is one of:  
SMMUL: Signed most significant word multiply  
R: a rounding error flag. If R is specified, the result is rounded instead of being truncated. In this case the constant 0x80000000 is added to the product before the high word is extracted.
- 'cond' is an optional condition code (see [Conditional execution on page 64](#))
- 'Rd' is the destination register.
- 'Rn', 'Rm' are registers holding the first and second operands

Operation

The SMMUL instruction interprets the values from *Rn* and *Rm* as two's complement 32-bit signed integers. The SMMUL instruction:

1. Multiplies the values from *Rn* and *Rm*.
2. Optionally rounds the result, otherwise truncates the result.
3. Writes the most significant signed 32 bits of the result in *Rd*.

Restrictions

In this instruction: Do not use SP or PC.

Condition flags

This instruction does not affect the condition code flags.

Examples

```
SMULL   R0, R4, R5    ; Multiplies R4 and R5, truncates top 32 bits
           ; and writes to R0
SMULLR  R6, R2        ; Multiplies R6 and R2, rounds the top 32 bits
           ; and writes to R6.
```

### 3.6.9 SMUAD and SMUSD

Signed dual multiply add and Signed dual multiply subtract

Syntax

`op{X}{cond} Rd, Rn, Rm`

where:

- `op` is one of:
  - SMUAD: Signed dual multiply add.
  - SMUADX: Signed dual multiply add reversed.
  - SMUSD: Signed dual multiply subtract.
  - SMUSDX: Signed dual multiply subtract reversed.
  - If `X` is present, the multiplications are bottom × top and top × bottom.
  - If the `X` is omitted, the multiplications are bottom × bottom and top × top.
- '`cond`' is an optional condition code (see [Conditional execution on page 64](#))
- '`Rd`' is the destination register.
- '`Rn`', '`Rm`' are registers holding the first and second operands

Operation

SMUAD interprets first and second operand values as two signed halfwords:

1. Optionally rotates the halfwords of the second operand.
2. Performs two signed 16 × 16-bit multiplications.
3. Adds the two multiplication results together.
4. Writes the result of the addition to the destination register.

SMUSD interprets the values from the first and second operands as two's complement signed integers:

1. Optionally rotates the halfwords of the second operand.
2. Performs two signed 16 × 16-bit multiplications.
3. Subtracts the result of the top halfword multiplication from the result of the bottom halfword multiplication.
4. Writes the result of the subtraction to the destination register.

Restrictions

In these instructions: Do not use SP or PC.

Condition flags

Sets the Q flag if the addition overflows. The multiplications cannot overflow.

Examples

```
SMUAD   R0, R4, R5 ; Multiplies bottom halfword of R4 with the bottom
                ; halfword of R5, adds multiplication of top halfword
                ; of R4 with top halfword of R5, writes to R0
SMUADX  R3, R7, R4 ; Multiplies bottom halfword of R7 with top halfword
                ; of R4, adds multiplication of top halfword of R7
                ; with bottom halfword of R4, writes to R3
SMUSD   R3, R6, R2 ; Multiplies bottom halfword of R4 with bottom halfword
                ; of R6, subtracts multiplication of top halfword of R6
```



```

; with top halfword of R3, writes to R3
SMUSDIX R4, R5, R3 ; Multiplies bottom halfword of R5 with top halfword of
; R3, subtracts multiplication of top halfword of R5
; with bottom halfword of R3, writes to R4.

```

### 3.6.10 SMUL and SMULW

Signed multiply (halfwords) and Signed multiply (word by halfword)

Syntax

```
op{XY}{cond} Rd, Rn, Rm
```

```
op{Y}{cond} Rd, Rn, Rm
```

- `op` is one of:
  - SMUL{XY} Signed multiply (halfwords). X and Y specify which halfword of the source registers *Rn* and *Rm* is used as the first and second multiply operand.
    - If X is B, then the bottom halfword, bits [15:0] of *Rn* is used.
    - If X is T, then the top halfword, bits [31:16] of *Rn* is used.
    - If Y is B, then the bottom halfword, bits [15:0], of *Rm* is used.
    - If Y is T, then the top halfword, bits [31:16], of *Rm* is used.
  - SMULW{Y} Signed multiply (word by halfword). Y specifies which halfword of the source register *Rm* is used as the second multiply operand.
    - If Y is B, then the bottom halfword (bits [15:0]) of *Rm* is used.
    - If Y is T, then the top halfword (bits [31:16]) of *Rm* is used.
- '`cond`' is an optional condition code (see [Conditional execution on page 64](#))
- '`Rd`' is the destination register.
- '`Rn`', '`Rm`' are registers holding the first and second operands

Operation

The SMULBB, SMULTB, SMULBT and SMULTT instructions interpret the values from *Rn* and *Rm* as four signed 16-bit integers. These instructions:

1. Multiply the specified signed halfword, top or bottom, values from *Rn* and *Rm*.
2. Write the 32-bit result of the multiplication in *Rd*.

The SMULWT and SMULWB instructions interpret the values from *Rn* as a 32-bit signed integer and *Rm* as two halfword 16-bit signed integers. These instructions:

1. Multiply the first operand and the top, T suffix, or the bottom, B suffix, halfword of the second operand.
2. Write the 32 signed most significant bits of the 48-bit result in the destination register.

Restrictions

Do not use SP and do not use PC.

Examples

```

SMULBT R0, R4, R5 ; Multiplies the bottom halfword of R4 with the top
; halfword of R5, multiplies results and writes to R0
SMULBB R0, R4, R5 ; Multiplies the bottom halfword of R4 with the bottom
; halfword of R5, multiplies results and writes to R0
SMULTT R0, R4, R5 ; Multiplies the top halfword of R4 with the top
; halfword of R5, multiplies results and writes to R0

```

```

SMULTB R0, R4, R5 ; Multiplies the top halfword of R4 with the bottom
                  ; halfword of R5, multiplies results and writes to R0
SMULWT R4, R5, R3 ; Multiplies R5 with the top halfword of R3,
                  ; extracts top 32 bits and writes to R4
SMULWB R4, R5, R3 ; Multiplies R5 with the bottom halfword of R3,
                  ; extracts top 32 bits and writes to R4.

```

### 3.6.11 UMULL, UMLAL, SMULL, and SMLAL

Signed and Unsigned long multiply, with optional Accumulate, using 32-bit operands and producing a 64-bit result.

#### Syntax

```
op{cond} RdLo, RdHi, Rn, Rm
```

where:

- *op* is one of:  
 UMULL: Unsigned long multiply.  
 UMLAL: Unsigned long multiply, with accumulate.  
 SMULL: Signed long multiply.  
 SMLAL: Signed long multiply, with accumulate.
- '*cond*' is an optional condition code (see [Conditional execution on page 64](#))
- '*RdHi*, *RdLo*' are the destination registers. For UMLAL and SMLAL they also hold the accumulating value.
- '*Rn*', '*Rm*' are registers holding the operands

#### Operation

The UMULL instruction interprets the values from *Rn* and *Rm* as unsigned integers. It multiplies these integers and places the least significant 32 bits of the result in *RdLo*, and the most significant 32 bits of the result in *RdHi*.

The UMLAL instruction interprets the values from *Rn* and *Rm* as unsigned integers. It multiplies these integers, adds the 64-bit result to the 64-bit unsigned integer contained in *RdHi* and *RdLo*, and writes the result back to *RdHi* and *RdLo*.

The SMULL instruction interprets the values from *Rn* and *Rm* as two's complement signed integers. It multiplies these integers and places the least significant 32 bits of the result in *RdLo*, and the most significant 32 bits of the result in *RdHi*.

The SMLAL instruction interprets the values from *Rn* and *Rm* as two's complement signed integers. It multiplies these integers, adds the 64-bit result to the 64-bit signed integer contained in *RdHi* and *RdLo*, and writes the result back to *RdHi* and *RdLo*.

#### Restrictions

In these instructions:

- Do not use SP or PC
- *RdHi* and *RdLo* must be different registers.

#### Condition flags

These instructions do not affect the condition code flags.

**Examples**

```

UMULL      R0, R4, R5, R6 ; Unsigned (R4,R0) = R5 x R6
SMLAL     R4, R5, R3, R8 ; Signed (R5,R4) = (R5,R4) + R3 x R8

```

**3.6.12 SDIV and UDIV**

Signed divide and unsigned divide.

**Syntax**

```

SDIV{cond} {Rd,} Rn, Rm
UDIV{cond} {Rd,} Rn, Rm

```

where:

- ‘*cond*’ is an optional condition code (see [Conditional execution on page 64](#))
- ‘*Rd*’ is the destination register. If *Rd* is omitted, the destination register is *Rn*
- ‘*Rn*,’ is the register holding the value to be divided
- ‘*Rm*’ is a register holding the divisor

**Operation**

SDIV performs a signed integer division of the value in *Rn* by the value in *Rm*.

UDIV performs an unsigned integer division of the value in *Rn* by the value in *Rm*.

For both instructions, if the value in *Rn* is not divisible by the value in *Rm*, the result is rounded towards zero.

**Restrictions**

Do not use either SP or PC.

**Condition flags**

These instructions do not change the flags.

**Examples**

```

SDIV R0, R2, R4; signed divide, R0 = R2/R4
UDIV R8, R8, R1; unsigned divide, R8 = R8/R1

```

### 3.7 Saturating instructions

This section describes the saturating instructions.

**Table 30. Saturating instructions**

Mnemonic	Brief description	See
SSAT	Signed Saturate	<a href="#">SSAT and USAT on page 125</a>
SSAT16	Signed Saturate Halfword	<a href="#">SSAT16 and USAT16 on page 126</a>
USAT	Unsigned Saturate	<a href="#">SSAT and USAT on page 125</a>
USAT16	Unsigned Saturate Halfword	<a href="#">SSAT16 and USAT16 on page 126</a>
QADD	Saturating Add	<a href="#">QADD and QSUB on page 127</a>
QSUB	Saturating Subtract	<a href="#">QADD and QSUB on page 127</a>
QSUB16	Saturating Subtract 16	<a href="#">QADD and QSUB on page 127</a>
QASX	Saturating Add and Subtract with Exchange	<a href="#">QASX and QSAX on page 128</a>
QSAX	Saturating Subtract and Add with Exchange	<a href="#">QASX and QSAX on page 128</a>
QDADD	Saturating Double and Add	<a href="#">QDADD and QDSUB on page 129</a>
QDSUB	Saturating Double and Subtract	<a href="#">QDADD and QDSUB on page 129</a>
UQADD16	Unsigned Saturating Add 16	<a href="#">UQADD and UQSUB on page 131</a>
UQADD8	Unsigned Saturating Add 8	<a href="#">UQADD and UQSUB on page 131</a>
UQASX	Unsigned Saturating Add and Subtract with Exchange	<a href="#">UQASX and UQSAX on page 130</a>
UQSAX	Unsigned Saturating Subtract and Add with Exchange	<a href="#">UQASX and UQSAX on page 130</a>
UQSUB16	Unsigned Saturating Subtract 16	<a href="#">UQADD and UQSUB on page 131</a>
UQSUB8	Unsigned Saturating Subtract 8	<a href="#">UQADD and UQSUB on page 131</a>

For signed  $n$ -bit saturation, this means that:

- if the value to be saturated is less than  $-2^{n-1}$ , the result returned is  $-2^{n-1}$
- if the value to be saturated is greater than  $2^{n-1}-1$ , the result returned is  $2^{n-1}-1$
- otherwise, the result returned is the same as the value to be saturated.

For unsigned  $n$ -bit saturation, this means that:

- if the value to be saturated is less than 0, the result returned is 0
- if the value to be saturated is greater than  $2^{n-1}$ , the result returned is  $2^{n-1}$
- otherwise, the result returned is the same as the value to be saturated.

If the returned result is different from the value to be saturated, it is called saturation. If saturation occurs, the instruction sets the Q flag to 1 in the APSR. Otherwise, it leaves the Q flag unchanged. To clear the Q flag to 0, you must use the MSR instruction, see [MSR on page 174](#).

To read the state of the Q flag, use the MRS instruction, see [MRS on page 173](#).

### 3.7.1 SSAT and USAT

Signed Saturate and Unsigned Saturate to any bit position, with optional shift before saturating.

Syntax

```
op{cond} Rd, #n, Rm {, shift #s}
```

where:

- *op* is one of:
  - SSAT: Saturates a signed value to a signed range.
  - USAT: Saturates a signed value to an unsigned range.
- '*cond*' is an optional condition code (see [Conditional execution on page 64](#))
- '*Rd*' is the destination register.
- '*n*' specifies the bit position to saturate to:
  - n* ranges from 1 to 32 for SSAT
  - n* ranges from 0 to 31 for USAT.
- '*Rm*' is the register containing the value to saturate.
- '*shift #s*' is an optional shift applied to *Rm* before saturating. It must be one of the following:
  - ASR #s: where *s* is in the range 1 to 31
  - LSL #s: where *s* is in the range 0 to 31.

Operation

These instructions saturate to a signed or unsigned *n*-bit value.

The SSAT instruction applies the specified shift, then saturates to the signed range  $-2^{n-1} \leq x \leq 2^{n-1}-1$ .

The USAT instruction applies the specified shift, then saturates to the unsigned range  $0 \leq x \leq 2^{n-1}$ .

#### Restrictions

Do not use SP and do not use PC.

Condition flags

These instructions do not affect the condition code flags.

If saturation occurs, these instructions set the Q flag to 1.

Examples

```
SSAT    R7, #16, R7, LSL #4 ; Logical shift left value in R7 by 4, then
                               ; saturate it as a signed 16-bit value and
                               ; write it back to R7
```

```
USATNE  R0, #7, R5; Conditionally saturate value in R5 as an
                               ; unsigned 7 bit value and write it to R0.
```

### 3.7.2 SSAT16 and USAT16

Signed Saturate and Unsigned Saturate to any bit position for two halfwords.

Syntax

```
op{cond} Rd, #n, Rm
```

where:

- *op* is one of:
  - SSAT16 Saturates a signed halfword value to a signed range.
  - USAT16 Saturates a signed halfword value to an unsigned range.
- '*cond*' is an optional condition code (see [Conditional execution on page 64](#))
- '*Rd*' is the destination register.
- '*n*' specifies the bit position to saturate to:
  - n* ranges from 1 to 16 for SSAT.
  - n* ranges from 0 to 15 for USAT.
- '*Rm*' is the register containing the value to saturate.

Operation

The SSAT16 instruction:

1. Saturates two signed 16-bit halfword values of the register with the value to saturate from selected by the bit position in *n*.
2. Writes the results as two signed 16-bit halfwords to the destination register.

The USAT16 instruction:

1. Saturates two unsigned 16-bit halfword values of the register with the value to saturate from selected by the bit position in *n*.
2. Writes the results as two unsigned halfwords in the destination register.

#### Restrictions

Do not use SP and do not use PC.

Condition flags

These instructions do not affect the condition code flags.

If saturation occurs, these instructions set the Q flag to 1.

Examples

```
SSAT16 R7, #9, R2 ; Saturates the top and bottom highwords of R2
                  ; as 9-bit values, writes to corresponding halfword
                  ; of R7
USAT16NE R0, #13, R5 ; Conditionally saturates the top and bottom
                    ; halfwords of R5 as 13-bit values, writes to
                    ; corresponding halfword of R0.
```

### 3.7.3 QADD and QSUB

Saturating Add and Saturating Subtract, signed.

Syntax

```
op{cond} {Rd}, Rn, Rm
```

```
op{cond} {Rd}, Rn, Rm
```

where:

- *op* is one of:  
 QADD: Saturating 32-bit add.  
 QADD8: Saturating four 8-bit integer additions.  
 QADD16: Saturating two 16-bit integer additions.  
 QSUB: Saturating 32-bit subtraction.  
 QSUB8: Saturating four 8-bit integer subtraction.  
 QSUB16: Saturating two 16-bit integer subtraction.
- '*cond*' is an optional condition code (see [Conditional execution on page 64](#))
- '*Rd*' is the destination register.
- '*Rn, Rm*' are registers holding the first and second operands.

Operation

These instructions add or subtract two, four or eight values from the first and second operands and then write a signed saturated value in the destination register.

The QADD and QSUB instructions apply the specified add or subtract, and then saturate the result to the signed range  $-2^{n-1} \leq x \leq 2^{n-1}-1$ , where *x* is given by the number of bits applied in the instruction, 32, 16 or 8.

If the returned result is different from the value to be saturated, it is called saturation. If saturation occurs, the QADD and QSUB instructions set the APSR Q flag to 1. Otherwise, Q flag is unchanged. The 8-bit and 16-bit QADD and QSUB instructions always leave Q flag unchanged.

To clear the Q flag to 0, you must use the MSR instruction, see [MSR on page 174](#).

To read the state of the Q flag, use the MRS instruction, see [MRS on page 173](#).

#### Restrictions

Do not use SP and do not use PC.

Condition flags

These instructions do not affect the condition code flags.

If saturation occurs, these instructions set the Q flag to 1.

Examples

```
QADD16 R7, R4, R2 ; Adds halfwords of R4 with corresponding halfword of
                  ; R2, saturates to 16 bits and writes to corresponding
                  ; halfword of R7
```

```
QADD8 R3, R1, R6 ; Adds bytes of R1 to corresponding bytes of R6, saturates
                  ; to 8 bits and writes to corresponding byte of R3
```

```
QSUB16 R4, R2, R3 ; Subtracts halfwords of R3 from corresponding halfword
                  ; of R2, saturates to 16 bits, writes to corresponding
```

```

; halfword of R4
QSUB8 R4, R2, R5 ; Subtracts bytes of R5 from the corresponding byte in R2
; saturates to 8 bits, writes to corresponding byte of R4.

```

### 3.7.4 QASX and QSAX

Saturating Add and Subtract with Exchange and Saturating Subtract and Add with Exchange, signed.

#### Syntax

```
op{cond} {Rd}, Rm, Rn
```

where:

- *op* is one of:  
QASX Add and Subtract with Exchange and Saturate.  
QSAX Subtract and Add with Exchange and Saturate.
- '*cond*' is an optional condition code (see [Conditional execution on page 64](#))
- '*Rd*' is the destination register.
- '*Rn, Rm*' are registers holding the first and second operands.

#### Operation

The QASX instruction:

1. Adds the top halfword of the source operand with bottom halfword of second operand.
2. Subtracts the top halfword of second operand from bottom highword of first operand.
3. Saturates the result of the subtraction and writes a 16-bit signed integer in the range  $-2^{15} \leq x \leq 2^{15} - 1$ , where *x* equals 16, to the bottom halfword of the destination register.
4. Saturates the results of the sum and writes a 16-bit signed integer in the range
5.  $-2^{15} \leq x \leq 2^{15} - 1$ , where *x* equals 16, to the top halfword of the destination register.

The QSAX instruction:

1. Subtracts the bottom halfword of second operand from top highword of first operand.
2. Adds the bottom halfword of source operand with top halfword of second operand.
3. Saturates the results of the sum and writes a 16-bit signed integer in the range
4.  $-2^{15} \leq x \leq 2^{15} - 1$ , where *x* equals 16, to the bottom halfword of the destination register.
5. Saturates the result of the subtraction and writes a 16-bit signed integer in the range  $-2^{15} \leq x \leq 2^{15} - 1$ , where *x* equals 16, to the top halfword of the destination register.

#### Restrictions

Do not use SP and do not use PC.

#### Condition flags

These instructions do not affect the condition code flags.

#### Examples

```

QASX R7, R4, R2 ; Adds top halfword of R4 to bottom halfword of R2,
; saturates to 16 bits, writes to top halfword of R7
; Subtracts top highword of R2 from bottom halfword of
; R4, saturates to 16 bits and writes to bottom halfword
; of R7

```



```

QSAX R0, R3, R5 ; Subtracts bottom halfword of R5 from top halfword of
                 ; R3, saturates to 16 bits, writes to top halfword of R0
                 ; Adds bottom halfword of R3 to top halfword of R5,
                 ; saturates to 16 bits, writes to bottom halfword of R0.

```

### 3.7.5 QDADD and QDSUB

Saturating Double and Add and Saturating Double and Subtract, signed.

Syntax

```
op{cond} {Rd}, Rm, Rn
```

where:

- *op* is one of:  
   QDADD Saturating Double and Add.  
   QDSUB Saturating Double and Subtract.
- '*cond*' is an optional condition code (see [Conditional execution on page 64](#))
- '*Rd*' is the destination register.
- '*Rn, Rm*' are registers holding the first and second operands.

Operation

The QDADD instruction:

1. Doubles the second operand value.
2. Adds the result of the doubling to the signed saturated value in the first operand.
3. Writes the result to the destination register.

The QDSUB instruction:

1. Doubles the second operand value.
2. Subtracts the doubled value from the signed saturated value in the first operand.
3. Writes the result to the destination register.

Both the doubling and the addition or subtraction have their results saturated to the 32-bit signed integer range  $-2^{31} \leq x \leq 2^{31} - 1$ . If saturation occurs in either operation, it sets the Q flag in the APSR.

#### Restrictions

Do not use SP and do not use PC.

Condition flags

If saturation occurs, these instructions set the Q flag to 1.

Examples

```

QDADD  R7, R4, R2 ; Doubles and saturates R4 to 32 bits, adds R2,
                 ; saturates to 32 bits, writes to R7
QDSUB  R0, R3, R5 ; Subtracts R3 doubled and saturated to 32 bits
                 ; from R5, saturates to 32 bits, writes to R0.

```

### 3.7.6 UQASX and UQSAX

Saturating Add and Subtract with Exchange and Saturating Subtract and Add with Exchange, unsigned.

#### Syntax

`op{cond} {Rd}, Rm, Rn`

where:

- *op* is one of:  
UQASX Add and Subtract with Exchange and Saturate.  
UQSAX Subtract and Add with Exchange and Saturate.
- '*cond*' is an optional condition code (see [Conditional execution on page 64](#))
- '*Rd*' is the destination register.
- '*Rn, Rm*' are registers holding the first and second operands.

#### Operation

The UQASX instruction:

1. Adds the bottom halfword of the source operand with top halfword of second operand.
2. Subtracts the bottom halfword of the second operand from the top highword of the first operand.
3. Saturates the results of the sum and writes a 16-bit unsigned integer in the range
4.  $0 \leq x \leq 2^{16} - 1$ , where *x* equals 16, to the top halfword of the destination register.
5. Saturates the result of the subtraction and writes a 16-bit unsigned integer in the range  $0 \leq x \leq 2^{16} - 1$ , where *x* equals 16, to the bottom halfword of the destination register.

The UQSAX instruction:

1. Subtracts the bottom halfword of second operand from top highword of first operand.
2. Adds the bottom halfword of the first operand with the top halfword of the second operand.
3. Saturates the result of the subtraction and writes a 16-bit unsigned integer in the range  $0 \leq x \leq 2^{16} - 1$ , where *x* equals 16, to the top halfword of the destination register.
4. Saturates the results of the addition and writes a 16-bit unsigned integer in the range  $0 \leq x \leq 2^{16} - 1$ , where *x* equals 16, to the bottom halfword of the destination register.

#### Restrictions

Do not use SP and do not use PC.

#### Condition flags

These instructions do not affect the condition code flags.

#### Examples

```
UQASX   R7, R4, R2 ; Adds top halfword of R4 with bottom halfword of R2,
                ; saturates to 16 bits, writes to top halfword of R7
                ; Subtracts top halfword of R2 from bottom halfword of
                ; R4, saturates to 16 bits, writes to bottom halfword of R7
UQSAX   R0, R3, R5 ; Subtracts bottom halfword of R5 from top halfword of
                ; R3, saturates to 16 bits, writes to top halfword of R0
```

```

; Adds bottom halfword of R4 to top halfword of R5
; saturates to 16 bits, writes to bottom halfword of R0.

```

### 3.7.7 UQADD and UQSUB

Saturating Add and Saturating Subtract Unsigned.

Syntax

```
op{cond} {Rd}, Rn, Rm
```

```
op{cond} {Rd}, Rn, Rm
```

where:

- *op* is one of:
  - UQADD8 Saturating four unsigned 8-bit integer additions.
  - UQADD16 Saturating two unsigned 16-bit integer additions.
  - UDSUB8 Saturating four unsigned 8-bit integer subtractions.
  - UQSUB16 Saturating two unsigned 16-bit integer subtractions.
- '*cond*' is an optional condition code (see [Conditional execution on page 64](#))
- '*Rd*' is the destination register.
- '*Rn, Rm*' are registers holding the first and second operands.

Operation

These instructions add or subtract two or four values and then writes an unsigned saturated value in the destination register.

The UQADD16 instruction:

1. Adds the respective top and bottom halfwords of the first and second operands.
2. Saturates the result of the additions for each halfword in the destination register to the unsigned range  $0 \leq x \leq 2^{16}-1$ , where *x* is 16.

The UQADD8 instruction:

1. Adds each respective byte of the first and second operands.
2. Saturates the result of the addition for each byte in the destination register to the unsigned range  $0 \leq x \leq 2^8-1$ , where *x* is 8.

The UQSUB16 instruction:

1. Subtracts both halfwords of the second operand from the respective halfwords of the first operand.
2. Saturates the result of the differences in the destination register to the unsigned range  $0 \leq x \leq 2^{16}-1$ , where *x* is 16.

The UQSUB8 instructions:

1. Subtracts the respective bytes of the second operand from the respective bytes of the first operand.
2. Saturates the results of the differences for each byte in the destination register to the unsigned range  $0 \leq x \leq 2^8-1$ , where *x* is 8.

#### Restrictions

Do not use SP and do not use PC.

Condition flags

These instructions do not affect the condition code flags.

**Examples**

```

UQADD16 R7, R4, R2; Adds halfwords in R4 to corresponding halfword in R2,
                    ; saturates to 16 bits, writes to corresponding halfword
                    ; of R7
UQADD8  R4, R2, R5 ; Adds bytes of R2 to corresponding byte of R5, saturates
                    ; to 8 bits, writes to corresponding bytes of R4
UQSUB16 R6, R3, R0 ; Subtracts halfwords in R0 from corresponding halfword
                    ; in R3, saturates to 16 bits, writes to corresponding
                    ; halfword in R6
UQSUB8  R1, R5, R6 ; Subtracts bytes in R6 from corresponding byte of R5,
                    ; saturates to 8 bits, writes to corresponding byte of
                    R1.
    
```

**3.8 Packing and unpacking instructions**

Table 31 shows the instructions that operate on packing and unpacking data:

**Table 31. Packing and unpacking instructions**

Mnemonic	Brief description	See
PKH	Pack Halfword	<a href="#">PKHBT and PKHTB on page 133</a>
SXTAB	Extend 8 bits to 32 and add	<a href="#">SXTA and UXTA on page 135</a>
SXTAB16	Dual extend 8 bits to 16 and add	<a href="#">SXTA and UXTA on page 135</a>
SXTAH	Extend 16 bits to 32 and add	<a href="#">SXTA and UXTA on page 135</a>
SXTB	Sign extend a byte	<a href="#">SXT and UXT on page 134</a>
SXTB16	Dual extend 8 bits to 16 and add	<a href="#">SXT and UXT on page 134</a>
SXTH	Sign extend a halfword	<a href="#">SXT and UXT on page 134</a>
UXTAB	Extend 8 bits to 32 and add	<a href="#">SXTA and UXTA on page 135</a>
UXTAB16	Dual extend 8 bits to 16 and add	<a href="#">SXTA and UXTA on page 135</a>
UXTAH	Extend 16 bits to 32 and add	<a href="#">SXTA and UXTA on page 135</a>
UXTB	Zero extend a byte	<a href="#">SXT and UXT on page 134</a>
UXTB16	Dual zero extend 8 bits to 16 and add	<a href="#">SXT and UXT on page 134</a>
UXTH	Zero extend a halfword	<a href="#">SXT and UXT on page 134</a>



### 3.8.1 PKHBT and PKHTB

Pack Halfword

Syntax

```
op{cond} {Rd}, Rn, Rm {, LSL #imm}
```

```
op{cond} {Rd}, Rn, Rm {, ASR #imm}
```

where:

- *op* is one of:
  - PKHBT Pack Halfword, bottom and top with shift.
  - PKHTB Pack Halfword, top and bottom with shift.
- '*cond*' is an optional condition code (see [Conditional execution on page 64](#))
- '*Rd*' is the destination register.
- '*Rn*' is the first operand register.
- '*Rm*' is the second operand register holding the value to be optionally shifted.
- '*imm*' is the shift length. The type of shift length depends on the instruction:
  - For PKHBT: LSL: a left shift with a shift length from 1 to 31, 0 means no shift.
  - For PKHTB: ASR: an arithmetic shift right with a shift length from 1 to 32, a shift of 32-bits is encoded as 0b00000.

#### Operation

The PKHBT instruction:

1. Writes the value of the bottom halfword of the first operand to the bottom halfword of the destination register.
2. If shifted, the shifted value of the second operand is written to the top halfword of the destination register.

The PKHTB instruction:

1. Writes the value of the top halfword of the first operand to the top halfword of the destination register.
2. If shifted, the shifted value of the second operand is written to the bottom halfword of the destination register.

#### Restrictions

Rd must not be SP and must not be PC.

#### Condition flags

This instruction does not change the flags.

#### Examples

```
PKHBT   R3, R4, R5 LSL #0 ; Writes bottom halfword of R4 to bottom halfword
                        ; of R3, writes top halfword of R5, unshifted, to top
                        ; halfword of R3
```

```
PKHTB   R4, R0, R2 ASR #1 ; Writes R2 shifted right by 1 bit to bottom half
                        ; word of R4, and writes top halfword of R0 to top
                        ; halfword of R4.
```

### 3.8.2 SXT and UXT

Sign extend and Zero extend.

Syntax

```
op{cond} {Rd}, Rm {, ROR #n}
op{cond} {Rd}, Rm {, ROR #n}
```

where:

- *op* is one of:
  - SXTB Sign extends an 8-bit value to a 32-bit value.
  - SXTH Sign extends a 16-bit value to a 32-bit value.
  - SXTB16 Sign extends two 8-bit values to two 16-bit values.
  - UXTB Zero extends an 8-bit value to a 32-bit value.
  - UXTH Zero extends a 16-bit value to a 32-bit value.
  - UXTB16 Zero extends two 8-bit values to two 16-bit values.
- '*cond*' is an optional condition code (see [Conditional execution on page 64](#))
- '*Rd*' is the destination register.
- '*Rm*' is the register holding the value to extend.
- '*ROR #n*' is one of:
  - ROR #8 Value from Rm is rotated right 8 bits.
  - ROR #16 Value from Rm is rotated right 16 bits.
  - ROR #24 Value from Rm is rotated right 24 bits.
  - If ROR #n is omitted, no rotation is performed.

#### Operation

These instructions do the following:

1. Rotate the value from Rm right by 0, 8, 16 or 24 bits.
2. Extract bits from the resulting value:
  - SXTB extracts bits[7:0] and sign extends to 32 bits.
  - UXTB extracts bits[7:0] and zero extends to 32 bits.
  - SXTH extracts bits[15:0] and sign extends to 32 bits.
  - UXTH extracts bits[15:0] and zero extends to 32 bits.
  - SXTB16 extracts bits[7:0] and sign extends to 16 bits, and extracts bits [23:16] and sign extends to 16 bits.
  - UXTB16 extracts bits[7:0] and zero extends to 16 bits, and extracts bits [23:16] and zero extends to 16 bits.

#### Restrictions

Do not use SP and do not use PC.

#### Condition flags

These instructions do not affect the flags.

#### Examples

```
SXTH R4, R6, ROR #16 ; Rotates R6 right by 16 bits, obtains bottom halfword
                    ; of result, sign extends to 32 bits and writes to R4
UXTB R3, R10 ; Extracts lowest byte of value in R10, zero extends, and
            ; writes to R3.
```

### 3.8.3 SXTA and UXTA

Signed and Unsigned Extend and Add

Syntax

```
op{cond} {Rd,} Rn, Rm {, ROR #n}
```

```
op{cond} {Rd,} Rn, Rm {, ROR #n}
```

where:

- *op* is one of:
  - SXTAB Sign extends an 8-bit value to a 32-bit value and add.
  - SXTAH Sign extends a 16-bit value to a 32-bit value and add.
  - SXTAB16 Sign extends two 8-bit values to two 16-bit values and add.
  - UXTAB Zero extends an 8-bit value to a 32-bit value and add.
  - UXTAH Zero extends a 16-bit value to a 32-bit value and add.
  - UXTAB16 Zero extends two 8-bit values to two 16-bit values and add.
- '*cond*' is an optional condition code (see [Conditional execution on page 64](#))
- '*Rd*' is the destination register.
- '*Rn*' is the first operand register.
- '*Rm*' is the register holding the value to rotate and extend.
- '*ROR #n*' is one of:
  - ROR #8 Value from Rm is rotated right 8 bits.
  - ROR #16 Value from Rm is rotated right 16 bits.
  - ROR #24 Value from Rm is rotated right 24 bits.
  - If ROR #n is omitted, no rotation is performed.

#### Operation

These instructions do the following:

1. Rotate the value from Rm right by 0, 8, 16 or 24 bits.
2. Extract bits from the resulting value:
  - SXTAB extracts bits[7:0] from Rm and sign extends to 32 bits.
  - UXTAB extracts bits[7:0] from Rm and zero extends to 32 bits.
  - SXTAH extracts bits[15:0] from Rm and sign extends to 32 bits.
  - UXTAH extracts bits[15:0] from Rm and zero extends to 32 bits.
  - SXTAB16 extracts bits[7:0] from Rm and sign extends to 16 bits, and extracts bits [23:16] from Rm and sign extends to 16 bits.
  - UXTAB16 extracts bits[7:0] from Rm and zero extends to 16 bits, and extracts bits [23:16] from Rm and zero extends to 16 bits.
3. Adds the signed or zero extended value to the word or corresponding halfword of Rn and writes the result in Rd.

#### Restrictions

Do not use SP and do not use PC.

#### Condition flags

These instructions do not affect the flags.

**Examples**

```
SXTAH R4, R8, R6, ROR #16 ; Rotates R6 right by 16 bits, obtains bottom
                           ; halfword, sign extends to 32 bits, adds R8, and
                           ; writes to R4
UXTAB R3, R4, R10 ; Extracts bottom byte of R10 and zero extends to 32
                  ; bits, adds R4, and writes to R3.
```

**3.9 Bitfield instructions**

Table 32 shows the instructions that operate on adjacent sets of bits in registers or bitfields.

**Table 32. Instructions that operate on adjacent sets of bits**

Mnemonic	Brief description	See
BFC	Bit field clear	<a href="#">BFC and BFI on page 137</a>
BFI	Bit field insert	<a href="#">BFC and BFI on page 137</a>
SBFX	Signed bit field extract	<a href="#">SBFX and UBFX on page 138</a>
SXTB	Sign extend a byte	<a href="#">SXT and UXT on page 139</a>
SXTH	Sign extend a halfword	<a href="#">SXT and UXT on page 139</a>
UBFX	Unsigned bit field extract	<a href="#">SBFX and UBFX on page 138</a>
UXTB	Zero extend a byte	<a href="#">SXT and UXT on page 139</a>
UXTH	Zero extend a halfword	<a href="#">SXT and UXT on page 139</a>



### 3.9.1 BFC and BFI

Bit Field Clear and Bit Field Insert.

#### Syntax

```
BFC{cond} Rd, #lsb, #width
```

```
BFI{cond} Rd, Rn, #lsb, #width
```

where:

- ‘*cond*’ is an optional condition code, see [Conditional execution on page 64](#).
- ‘*Rd*’ is the destination register.
- ‘*Rn*’ is the source register.
- ‘*lsb*’ is the position of the least significant bit of the bitfield. *lsb* must be in the range 0 to 31.
- ‘*width*’ is the width of the bitfield and must be in the range 1 to 32-*lsb*.

#### Operation

BFC clears a bitfield in a register. It clears *width* bits in *Rd*, starting at the low bit position *lsb*. Other bits in *Rd* are unchanged.

BFI copies a bitfield into one register from another register. It replaces *width* bits in *Rd* starting at the low bit position *lsb*, with *width* bits from *Rn* starting at bit[0]. Other bits in *Rd* are unchanged.

#### Restrictions

Do not use SP and do not use PC.

#### Condition flags

These instructions do not affect the flags.

#### Examples

```
BFC  R4, #8, #12    ; Clear bit 8 to bit 19 (12 bits) of R4 to 0
BFI  R9, R2, #8, #12 ; Replace bit 8 to bit 19 (12 bits) of R9 with
                    ; bit 0 to bit 11 from R2
```

### 3.9.2 SBFX and UBFX

Signed Bit Field Extract and Unsigned Bit Field Extract.

#### Syntax

```
SBFX{cond} Rd, Rn, #lsb, #width
```

```
UBFX{cond} Rd, Rn, #lsb, #width
```

where:

- '*cond*' is an optional condition code, see [Conditional execution on page 64](#).
- '*Rd*' is the destination register.
- '*Rn*' is the source register.
- '*lsb*' is the position of the least significant bit of the bitfield. *lsb* must be in the range 0 to 31.
- '*width*' is the width of the bitfield and must be in the range 1 to 32-*lsb*.

#### Operation

SBFX extracts a bitfield from one register, sign extends it to 32 bits, and writes the result to the destination register.

UBFX extracts a bitfield from one register, zero extends it to 32 bits, and writes the result to the destination register.

#### Restrictions

Do not use SP and do not use PC.

#### Condition flags

These instructions do not affect the flags.

#### Examples

```
SBFX R0, R1, #20, #4 ; Extract bit 20 to bit 23 (4 bits) from R1 and sign  
                      ; extend to 32 bits and then write the result to R0.
```

```
UBFX R8, R11, #9, #10; Extract bit 9 to bit 18 (10 bits) from R11 and zero  
                      ; extend to 32 bits and then write the result to R8
```

### 3.9.3 SXT and UXT

Sign extend and Zero extend.

#### Syntax

```
SXTextend{cond} {Rd}, Rm {, ROR #n}
```

```
UXTextend{cond} {Rd}, Rm {, ROR #n}
```

where:

- ‘extend’ is one of:
  - B: Extends an 8-bit value to a 32-bit value.
  - H: Extends a 16-bit value to a 32-bit value.
- ‘cond’ is an optional condition code, see [Conditional execution on page 64](#).
- ‘Rd’ is the destination register.
- ‘Rm’ is the register holding the value to extend.
- ROR #n is one of:
  - ROR #8: Value from Rm is rotated right 8 bits.
  - ROR #16: Value from Rm is rotated right 16 bits.
  - ROR #24: Value from Rm is rotated right 24 bits.
 If ROR #n is omitted, no rotation is performed.

#### Operation

These instructions do the following:

1. Rotate the value from Rm right by 0, 8, 16 or 24 bits.
2. Extract bits from the resulting value:
  - SXTB extracts bits[7:0] and sign extends to 32 bits.
  - UXTB extracts bits[7:0] and zero extends to 32 bits.
  - SXTH extracts bits[15:0] and sign extends to 32 bits.
  - UXTH extracts bits[15:0] and zero extends to 32 bits.

#### Restrictions

Do not use SP and do not use PC.

#### Condition flags

These instructions do not affect the flags.

#### Examples

```
SXTH R4, R6, ROR #16 ; Rotate R6 right by 16 bits, then obtain the lower
                    ; halfword of the result and then sign extend to
                    ; 32 bits and write the result to R4.
UXTB R3, R10        ; Extract lowest byte of the value in R10 and zero
                    ; extend it, and write the result to R3
```

### 3.9.4 Branch and control instructions

[Table 33](#) shows the branch and control instructions:

**Table 33. Branch and control instructions**

<b>Mnemonic</b>	<b>Brief description</b>	<b>See</b>
B	Branch	<a href="#">B, BL, BX, and BLX on page 141</a>
BL	Branch with Link	<a href="#">B, BL, BX, and BLX on page 141</a>
BLX	Branch indirect with Link	<a href="#">B, BL, BX, and BLX on page 141</a>
BX	Branch indirect	<a href="#">B, BL, BX, and BLX on page 141</a>
CBNZ	Compare and Branch if Non Zero	<a href="#">CBZ and CBNZ on page 143</a>
CBZ	Compare and Branch if Non Zero	<a href="#">CBZ and CBNZ on page 143</a>
IT	If-Then	<a href="#">IT on page 144</a>
TBB	Table Branch Byte	<a href="#">TBB and TBH on page 146</a>
TBH	Table Branch Halfword	<a href="#">TBB and TBH on page 146</a>

### 3.9.5 B, BL, BX, and BLX

Branch instructions.

#### Syntax

$B\{cond\} \text{ label}$

$BL\{cond\} \text{ label}$

$BX\{cond\} Rm$

$BLX\{cond\} Rm$

where:

- 'B' is branch (immediate).
- 'BL' is branch with link (immediate).
- 'BX' is branch indirect (register).
- 'BLX' is branch indirect with link (register).
- '*cond*' is an optional condition code, see [Conditional execution on page 64](#).
- '*label*' is a PC-relative expression. See [PC-relative expressions on page 64](#).
- '*Rm*' is a register that indicates an address to branch to. Bit[0] of the value in *Rm* must be 1, but the address to branch to is created by changing bit[0] to 0.

#### Operation

All these instructions cause a branch to *label*, or to the address indicated in *Rm*. In addition:

- The BL and BLX instructions write the address of the next instruction to LR (the link register, R14).
- The BX and BLX instructions cause a UsageFault exception if bit[0] of *Rm* is 0.

*B cond label* is the only conditional instruction that can be either inside or outside an IT block. All other branch instructions must be conditional inside an IT block, and must be unconditional outside the IT block, see [IT on page 144](#).

[Table 34](#) shows the ranges for the various branch instructions.

**Table 34. Branch ranges**

Instruction	Branch range
B label	-16 MB to +16 MB
<i>Bcond</i> label (outside IT block)	-1 MB to +1 MB
<i>Bcond</i> label (inside IT block)	-16 MB to +16 MB
$BL\{cond\} \text{ label}$	-16 MB to +16 MB
$BX\{cond\} Rm$	Any value in register
$BLX\{cond\} Rm$	Any value in register

You might have to use the *.W* suffix to get the maximum branch range. See [Instruction width selection on page 67](#).

## Restrictions

The restrictions are:

- Do not use PC in the BLX instruction
- For BX and BLX, bit[0] of *Rm* must be 1 for correct execution but a branch occurs to the target address created by changing bit[0] to 0
- When any of these instructions is inside an IT block, it must be the last instruction of the IT block.

*Bcond* is the only conditional instruction that is not required to be inside an IT block. However, it has a longer branch range when it is inside an IT block.

## Condition flags

These instructions do not change the flags.

## Examples

```
B      loopA ; Branch to loopA
BLE    ng    ; Conditionally branch to label ng
B.W    target ; Branch to target within 16MB range
BEQ    target ; Conditionally branch to target
BEQ.W  target ; Conditionally branch to target within 1MB
BL     funC  ; Branch with link (Call) to function funC, return address
        ; stored in LR
BX     LR    ; Return from function call
BXNE   R0    ; Conditionally branch to address stored in R0
BLX    R0    ; Branch with link and exchange (Call) to a address stored
        ; in R0
```

### 3.9.6 CBZ and CBNZ

Compare and branch on zero, compare and branch on non-zero.

#### Syntax

```
CBZ Rn, label
```

```
CBNZ Rn, label
```

where:

- '*Rn*' is the register holding the operand.
- '*label*' is the branch destination.

#### Operation

Use the CBZ or CBNZ instructions to avoid changing the condition code flags and to reduce the number of instructions.

CBZ *Rn*, *label* does not change condition flags but is otherwise equivalent to:

```
CMP      Rn, #0  
BEQ     label
```

CBNZ *Rn*, *label* does not change condition flags but is otherwise equivalent to:

```
CMP      Rn, #0  
BNE     label
```

#### Restrictions

The restrictions are:

- *Rn* must be in the range of R0 to R7
- The branch destination must be within 4 to 130 bytes after the instruction
- These instructions must not be used inside an IT block.

#### Condition flags

These instructions do not change the flags.

#### Examples

```
CBZ      R5, target ; Forward branch if R5 is zero  
CBNZ     R0, target ; Forward branch if R0 is not zero
```

### 3.9.7 IT

If-Then condition instruction.

#### Syntax

```
IT{x{y{z}}} cond
```

where:

- 'x' specifies the condition switch for the second instruction in the IT block.
- 'y' specifies the condition switch for the third instruction in the IT block.
- 'z' specifies the condition switch for the fourth instruction in the IT block.
- 'cond' specifies the condition for the first instruction in the IT block.

The condition switch for the second, third and fourth instruction in the IT block can be either:

T: Then. Applies the condition *cond* to the instruction.

E: Else. Applies the inverse condition of *cond* to the instruction.

- b) It is possible to use AL (the *always* condition) for *cond* in an IT instruction. If this is done, all of the instructions in the IT block must be unconditional, and each of x, y, and z must be T or omitted but not E.

#### Operation

The IT instruction makes up to four following instructions conditional. The conditions can be all the same, or some of them can be the logical inverse of the others. The conditional instructions following the IT instruction form the *IT block*.

The instructions in the IT block, including any branches, must specify the condition in the *{cond}* part of their syntax.

Your assembler might be able to generate the required IT instructions for conditional instructions automatically, so that you do not need to write them yourself. See your assembler documentation for details.

A BKPT instruction in an IT block is always executed, even if its condition fails.

Exceptions can be taken between an IT instruction and the corresponding IT block, or within an IT block. Such an exception results in entry to the appropriate exception handler, with suitable return information in LR and stacked PSR.

Instructions designed for use for exception returns can be used as normal to return from the exception, and execution of the IT block resumes correctly. This is the only way that a PC-modifying instruction is permitted to branch to an instruction in an IT block.

#### Restrictions

The following instructions are not permitted in an IT block:

- IT
- CBZ and CBNZ
- CPSID and CPSIE.



Other restrictions when using an IT block are:

- a branch or any instruction that modifies the PC must either be outside an IT block or must be the last instruction inside the IT block. These are:
  - ADD PC, PC, Rm
  - MOV PC, Rm
  - B, BL, BX, BLX
  - any LDM, LDR, or POP instruction that writes to the PC
  - TBB and TBH
- Do not branch to any instruction inside an IT block, except when returning from an exception handler
- All conditional instructions except *Bcond* must be inside an IT block. *Bcond* can be either outside or inside an IT block but has a larger branch range if it is inside one
- Each instruction inside the IT block must specify a condition code suffix that is either the same or logical inverse as for the other instructions in the block.

Your assembler might place extra restrictions on the use of IT blocks, such as prohibiting the use of assembler directives within them.

## Condition flags

This instruction does not change the flags.

### Example

```

ITTE  NE           ; Next 3 instructions are conditional
ANDNE R0, R0, R1  ; ANDNE does not update condition flags
ADDSNE R2, R2, #1 ; ADDSNE updates condition flags
MOVEQ R2, R3      ; Conditional move

CMP   R0, #9      ; Convert R0 hex value (0 to 15) into ASCII
                        ; ('0'-'9', 'A'-'F')
ITE   GT           ; Next 2 instructions are conditional
ADDGT R1, R0, #55 ; Convert 0xA -> 'A'
ADDLE R1, R0, #48 ; Convert 0x0 -> '0'

IT    GT           ; IT block with only one conditional instruction
ADDGT R1, R1, #1  ; Increment R1 conditionally

ITTEE EQ           ; Next 4 instructions are conditional
MOVEQ R0, R1      ; Conditional move
ADDEQ R2, R2, #10 ; Conditional add
ANDNE R3, R3, #1  ; Conditional AND
BNE.W dloop       ; Branch instruction can only be used in the last
                        ; instruction of an IT block

IT    NE           ; Next instruction is conditional
ADD   R0, R0, R1  ; Syntax error: no condition code used in IT block

```

### 3.9.8 TBB and TBH

Table Branch Byte and Table Branch Halfword.

#### Syntax

TBB [*Rn*, *Rm*]

TBH [*Rn*, *Rm*, LSL #1]

where:

- '*Rn*' is the register containing the address of the table of branch lengths.  
If *Rn* is PC, then the address of the table is the address of the byte immediately following the TBB or TBH instruction.
- '*Rm*' is the index register. This contains an index into the table. For halfword tables, LSL #1 doubles the value in *Rm* to form the right offset into the table.

#### Operation

These instructions cause a PC-relative forward branch using a table of single byte offsets for TBB, or halfword offsets for TBH. *Rn* provides a pointer to the table, and *Rm* supplies an index into the table. For TBB the branch offset is twice the unsigned value of the byte returned from the table. and for TBH the branch offset is twice the unsigned value of the halfword returned from the table. The branch occurs to the address at that offset from the address of the byte immediately after the TBB or TBH instruction.

#### Restrictions

The restrictions are:

- *Rn* must not be SP
- *Rm* must not be SP and must not be PC
- When any of these instructions is used inside an IT block, it must be the last instruction of the IT block.

#### Condition flags

These instructions do not change the flags.

#### Examples

```
ADR.W R0, BranchTable_Byte
TBB [R0, R1] ; R1 is the index, R0 is the base address of the branch table
Case1
    ; an instruction sequence follows
Case2
    ; an instruction sequence follows
Case3
    ; an instruction sequence follows
BranchTable_Byte
DCB 0 ; Case1 offset calculation
DCB ((Case2-Case1)/2) ; Case2 offset calculation
DCB ((Case3-Case1)/2) ; Case3 offset calculation
```

```
TBH    [PC, R1, LSL #1]    ; R1 is the index, PC is used as base of the
                                ; branch table
BranchTable_H
DCI    ((CaseA - BranchTable_H)/2) ; CaseA offset calculation
DCI    ((CaseB - BranchTable_H)/2) ; CaseB offset calculation
DCI    ((CaseC - BranchTable_H)/2) ; CaseC offset calculation

CaseA
                                ; an instruction sequence follows
CaseB
                                ; an instruction sequence follows
CaseC
                                ; an instruction sequence follows
```

### 3.10 Floating-point instructions

These instructions are only available if the FPU is included, and enabled, in the system. See [Enabling the FPU on page 241](#) for information about enabling the floating-point unit.

**Table 35. Floating-point instructions**

Mnemonic	Brief description	See
VABS	Floating-point Absolute	<a href="#">VABS on page 149</a>
VADD	Floating-point Add	<a href="#">VADD on page 150</a>
VCMP	Compare two floating-point registers, or one floating-point register and zero	<a href="#">VCMP, VCMPE on page 150</a>
VCMPE	Compare two floating-point registers, or one floating-point register and zero with Invalid Operation check	<a href="#">VCMP, VCMPE on page 150</a>
VCVT	Convert between floating-point and integer	<a href="#">VCVT, VCVTR between floating-point and integer on page 151</a>
VCVT	Convert between floating-point and fixed point	<a href="#">VCVT between floating-point and fixed-point on page 152</a>
VCVTR	Convert between floating-point and integer with rounding	<a href="#">VCVT, VCVTR between floating-point and integer on page 151</a>
VCVTB	Converts half-precision value to single-precision	<a href="#">VCVTB, VCVTT on page 153</a>
VCVTT	Converts single-precision register to half-precision	<a href="#">VCVTB, VCVTT on page 153</a>
VDIV	Floating-point Divide	<a href="#">VDIV on page 154</a>
VFMA	Floating-point Fused Multiply Accumulate	<a href="#">VFMA, VFMS on page 154</a>
VFNMA	Floating-point Fused Negate Multiply Accumulate	<a href="#">VFNMA, VFNMS on page 155</a>
VFMS	Floating-point Fused Multiply Subtract	<a href="#">VFMA, VFMS on page 154</a>
VFNMS	Floating-point Fused Negate Multiply Subtract	<a href="#">VFNMA, VFNMS on page 155</a>
VLDM	Load Multiple extension registers	<a href="#">VLDM on page 156</a>
VLDR	Loads an extension register from memory	<a href="#">VLDR on page 157</a>
VLMA	Floating-point Multiply Accumulate	<a href="#">VLMA, VLMS on page 158</a>
VLMS	Floating-point Multiply Subtract	<a href="#">VLMA, VLMS on page 158</a>
VMOV	Floating-point Move Immediate	<a href="#">VMOV immediate on page 158</a>
VMOV	Floating-point Move Register	<a href="#">VMOV register on page 159</a>
VMOV	Copy ARM core register to single precision	<a href="#">VMOV scalar to ARM core register on page 159</a>
VMOV	Copy 2 ARM core registers to 2 single precision	<a href="#">VMOV ARM core register to single precision on page 160</a>
VMOV	Copies between ARM core register to scalar	<a href="#">VMOV two ARM core registers to two single precision on page 161</a>
VMOV	Copies between Scalar to ARM core register	<a href="#">VMOV ARM Core register to scalar on page 162</a>

Table 35. Floating-point instructions

Mnemonic	Brief description	See
VMRS	Move to ARM core register from floating-point System Register	<a href="#">VMRS on page 162</a>
VMSR	Move to floating-point System Register from ARM Core register	<a href="#">VMSR on page 163</a>
VMUL	Multiply floating-point	<a href="#">VMUL on page 163</a>
VNEG	Floating-point negate	<a href="#">VNEG on page 164</a>
VNMLA	Floating-point multiply and add	<a href="#">VNMLA, VNMLS, VNMUL on page 165</a>
VNMLS	Floating-point multiply and subtract	<a href="#">VNMLA, VNMLS, VNMUL on page 165</a>
VNMUL	Floating-point multiply	<a href="#">VNMLA, VNMLS, VNMUL on page 165</a>
VPOP	Pop extension registers	<a href="#">VPOP on page 166</a>
VPUSH	Push extension registers	<a href="#">VPUSH on page 166</a>
VSQRT	Floating-point square root	<a href="#">VSQRT on page 167</a>
VSTM	Store Multiple extension registers	<a href="#">VSTM on page 167</a>
VSTR	Stores an extension register to memory	<a href="#">VSTR on page 168</a>
VSUB	Floating-point Subtract	<a href="#">VSUB on page 169</a>

### 3.10.1 VABS

Floating-point Absolute.

#### Syntax

VABS{cond}.F32 Sd, Sm

where:

- ‘cond’ is an optional condition code, see [Conditional execution on page 64](#).
- ‘Sd, Sm’ are the destination floating-point value and the operand floating-point value.

#### Operation

This instruction:

1. Takes the absolute value of the operand floating-point register.
2. Places the results in the destination floating-point register.

#### Restrictions

There are no restrictions.

Condition flags

The floating-point instruction clears the sign bit.

Examples

VABS.F32 S4, S6

### 3.10.2 VADD

Floating-point Add

Syntax

```
VADD{cond}.F32 {Sd,} Sn, Sm
```

where:

- ‘*cond*’ is an optional condition code, see [Conditional execution on page 64](#).
- ‘*Sd*’ is the destination floating-point value
- ‘*Sn, Sm*’ are the operand floating-point values.

Operation

This instruction:

1. Adds the values in the two floating-point operand registers.
2. Places the results in the destination floating-point register.

Restrictions

There are no restrictions.

Condition flags

This instruction does not change the flags.

Examples

```
VADD.F32 S4, S6, S7
```

### 3.10.3 VCMP, VCMPE

Compares two floating-point registers, or one floating-point register and zero.

Syntax

```
VCMP{E}{cond}.F32 Sd, Sm
```

```
VCMP{E}{cond}.F32 Sd, #0.0
```

where:

- ‘*cond*’ is an optional condition code, see [Conditional execution on page 64](#).
- ‘*E*’ If present, any NaN operand causes an Invalid Operation exception. Otherwise, only a signaling NaN causes the exception.
- ‘*Sd*’ is the floating-point operand to compare.
- ‘*Sm*’ is the floating-point operand that is compared with

Operation

This instruction:

1. Compares:
  - Two floating-point registers.
  - One floating-point register and zero.
1. Writes the result to the FPSCR flags.

Restrictions

This instruction can raise an Invalid Operation exception if either operand is any type of NaN. It always raises an Invalid **Operation** exception if either operand is a signaling NaN.

### Condition flags

When this instruction writes the result to the FPSCR flags, the values are normally transferred to the ARM flags by a subsequent VMRS instruction, see [VMRS on page 162](#).

### Examples

```
VCMP.F32    S4, #0.0
VCMP.F32    S4, S2
```

## 3.10.4 VCVT, VCVTR between floating-point and integer

Converts a value in a register from floating-point to a 32-bit integer.

### Syntax

```
VCVT{R}{cond}.Tm.F32 Sd, Sm
VCVT{cond}.F32.Tm Sd, Sm
```

where:

- ‘R’ .  
If R is specified, the operation uses the rounding mode specified by the FPSCR.  
If R is omitted, the operation uses the Round towards Zero rounding mode.
- ‘cond’ is an optional condition code, see [Conditional execution on page 64](#).
- ‘Tm’ is the data type for the operand. It must be one of:  
S32 signed 32-bit value.  
U32 unsigned 32-bit value.
- ‘Sd, Sm’ are the destination register and the operand register.

### Operation

These instructions:

1. Either
  - Converts a value in a register from floating-point value to a 32-bit integer.
  - Converts from a 32-bit integer to floating-point value.
2. Places the result in a second register.

The floating-point to integer operation normally uses the Round towards Zero rounding mode, but can optionally use the rounding mode specified by the FPSCR.

The integer to floating-point operation uses the rounding mode specified by the FPSCR.

### Restrictions

There are no restrictions.

### Condition flags

These instructions do not change the flags.

### 3.10.5 VCVT between floating-point and fixed-point

Converts a value in a register from floating-point to and from fixed-point.

Syntax

```
VCVT{cond}.Td.F32 Sd, Sd, #fbits
```

```
VCVT{cond}.F32.Td Sd, Sd, #fbits
```

where:

- ‘*cond*’ is an optional condition code, see [Conditional execution on page 64](#).
- ‘*Td*’ is the data type for the fixed-point number. It must be one of:
  - S16 signed 16-bit value.
  - U16 unsigned 16-bit value.
  - S32 signed 32-bit value.
  - U32 unsigned 32-bit value.
- ‘*Sd*’ is the destination register and the operand register.
- ‘*fbits*’ is the number of fraction bits in the fixed-point number:
  - If *Td* is S16 or U16, *fbits* must be in the range 0-16.
  - If *Td* is S32 or U32, *fbits* must be in the range 1-32.

Operation

These instructions:

Either

Converts a value in a register from floating-point to fixed-point.

Converts a value in a register from fixed-point to floating-point.

Places the result in a second register.

The floating-point values are single-precision.

The fixed-point value can be 16-bit or 32-bit. Conversions from fixed-point values take their operand from the low-order bits of the source register and ignore any remaining bits.

Signed conversions to fixed-point values sign-extend the result value to the destination register width.

Unsigned conversions to fixed-point values zero-extend the result value to the destination register width.

The floating-point to fixed-point operation uses the Round towards Zero rounding mode.

The fixed-point to floating-point operation uses the Round to Nearest rounding mode.

Restrictions

There are no restrictions.

Condition flags

These instructions do not change the flags.



### 3.10.6 VCVTB, VCVTT

Converts between a half-precision value and a single-precision value.

#### Syntax

`VCVT{y}{cond}.F32.F16 Sd, Sm`

`VCVT{y}{cond}.F16.F32 Sd, Sm`

where:

- ‘y’ Specifies which half of the operand register Sm or destination register Sd is used for the operand or destination:
  - If y is B, then the bottom half, bits [15:0], of Sm or Sd is used.
  - If y is T, then the top half, bits [31:16], of Sm or Sd is used.
- ‘cond’ is an optional condition code, see [Conditional execution on page 64](#).
- ‘Sd’ is the destination register
- ‘Sm’ is the operand register.

#### Operation

This instruction with the .F16.F32 suffix:

1. Converts the half-precision value in the top or bottom half of a single-precision register to single-precision.
2. Writes the result to a single-precision register.

This instruction with the .F32.F16 suffix:

1. Converts the value in a single-precision register to half-precision.
2. Writes the result into the top or bottom half of a single-precision register, preserving the other half of the target register.

#### Restrictions

There are no restrictions.

#### Condition flags

These instructions do not change the flags.

### 3.10.7 VDIV

Divides floating-point values.

Syntax

```
VDIV{cond}.F32 {Sd,} Sn, Sm
```

where:

- ‘*cond*’ is an optional condition code, see [Conditional execution on page 64](#).
- ‘*Sd*’ is the destination register
- ‘*Sn, Sm*’ are the operand registers.

Operation

This instruction:

1. Divides one floating-point value by another floating-point value.
2. Writes the result to the floating-point destination register.

Restrictions

There are no restrictions.

Condition flags

These instructions do not change the flags.

### 3.10.8 VFMA, VFMS

Floating-point Fused Multiply Accumulate and Subtract.

Syntax

```
VFMA{cond}.F32 {Sd,} Sn, Sm
```

```
VFMS{cond}.F32 {Sd,} Sn, Sm
```

where:

- ‘*cond*’ is an optional condition code, see [Conditional execution on page 64](#).
- ‘*Sd*’ is the destination register
- ‘*Sn, Sm*’ are the operand registers.

Operation

The VFMA instruction:

1. Multiplies the floating-point values in the operand registers.
2. Accumulates the results into the destination register.
3. The result of the multiply is not rounded before the accumulation.

The VFMS instruction:

1. Negates the first operand register.
2. Multiplies the floating-point values of the first and second operand registers.
3. Adds the products to the destination register.
4. Places the results in the destination register.
5. The result of the multiply is not rounded before the addition.

Restrictions

There are no restrictions.

Condition flags

These instructions do not change the flags.

### 3.10.9 VFNMA, VFNMS

Floating-point Fused Negate Multiply Accumulate and Subtract.

Syntax

```
VFNMA{cond}.F32 {Sd,} Sn, Sm
```

```
VFNMS{cond}.F32 {Sd,} Sn, Sm
```

where:

- ‘*cond*’ is an optional condition code, see [Conditional execution on page 64](#).
- ‘*Sd*’ is the destination register
- ‘*Sn, Sm*’ are the operand registers.

Operation

The VFNMA instruction:

1. Negates the first floating-point operand register.
2. Multiplies the first floating-point operand with second floating-point operand.
3. Adds the negation of the floating -point destination register to the product
4. Places the result into the destination register.

The result of the multiply is not rounded before the addition.

The VFNMS instruction:

1. Multiplies the first floating-point operand with second floating-point operand.
2. Adds the negation of the floating-point value in the destination register to the product.
3. Places the result in the destination register.

The result of the multiply is not rounded before the addition.

Restrictions

There are no restrictions.

Condition flags

These instructions do not change the flags.

### 3.10.10 VLDM

Floating-point Load Multiple

Syntax

```
VLDM{mode}{cond}{.size} Rn{!}, list
```

where:

- *'mode'* is the addressing mode:
  - IA: Increment After. The consecutive addresses start at the address specified in Rn.
  - DB: Decrement Before. The consecutive addresses end just before the address specified in Rn.
- *'cond'* is an optional condition code, see [Conditional execution on page 64](#).
- *'Size'* is an optional data size specifier.
- *'Rn'* is the base register. The SP can be used
- *'!'* is the command to the instruction to write a modified value back to Rn. This is required if mode == DB, and is optional if mode == IA.
- *'list'* is the list of extension registers to be loaded, as a list of consecutively numbered doubleword or singleword registers, separated by commas and surrounded by brackets.

Operation

This instruction loads multiple extension registers from consecutive memory locations using an address from an ARM core register as the base address.

Restrictions

The restrictions are:

- If size is present, it must be equal to the size in bits, 32 or 64, of the registers in list.
- For the base address, the SP can be used.
- In the ARM instruction set, if ! is not specified the PC can be used.
- list must contain at least one register. If it contains doubleword registers, it must not contain more than 16 registers.
- If using the Decrement Before addressing mode, the write back flag, !, must be appended to the base register specification.

Condition flags

These instructions do not change the flags.

### 3.10.11 VLDR

Loads a single extension register from memory

#### Syntax

```
VLDR{cond}{.64} Dd, [Rn{#imm}]  
VLDR{cond}{.64} Dd, label  
VLDR{cond}{.64} Dd, [PC, #imm]  
VLDR{cond}{.32} Sd, [Rn {, #imm}]  
VLDR{cond}{.32} Sd, label  
VLDR{cond}{.32} Sd, [PC, #imm]
```

where:

- '*cond*' is an optional condition code, see [Conditional execution on page 64](#).
- '*64*, *32*' are the optional data size specifiers.
- *Dd* is the destination register for a doubleword load.
- *Sd* is the destination register for a singleword load.
- *Rn* is the base register. The SP can be used.
- *imm* is the + or - immediate offset used to form the address. Permitted address values are multiples of 4 in the range 0 to 1020.
- *label* is the label of the literal data item to be loaded.

#### Operation

This instruction loads a single extension register from memory, using a base address from an ARM core register, with an optional offset.

#### Restrictions

There are no restrictions.

#### Condition flags

These instructions do not change the flags.

### 3.10.12 VLMA, VLMS

Multiplies two floating-point values, and accumulates or subtracts the results.

Syntax

VLMA{cond}.F32 Sd, Sn, Sm

VLMS{cond}.F32 Sd, Sn, Sm

where:

- ‘cond’ is an optional condition code, see [Conditional execution on page 64](#).
- ‘Sd’ is the destination floating-point value
- ‘Sn, Sm’ are the operand floating-point values.

Operation

The floating-point Multiply Accumulate instruction:

1. Multiplies two floating-point values.
2. Adds the results to the destination floating-point value.

The floating-point Multiply Subtract instruction:

1. Multiplies two floating-point values.
2. Subtracts the products from the destination floating-point value.

Places the results in the destination register.

Restrictions

There are no restrictions.

Condition flags

These instructions do not change the flags.

### 3.10.13 VMOV immediate

Move floating-point immediate

Syntax

VMOV{cond}.F32 Sd, #imm

where:

- ‘cond’ is an optional condition code, see [Conditional execution on page 64](#).
- ‘Sd’ is the branch destination
- ‘imm’ is a floating-point constant.

Operation

This instruction copies a constant value to a floating-point register.

Restrictions

There are no restrictions.

Condition flags

These instructions do not change the flags.

### 3.10.14 VMOV register

Copies the contents of one register to another.

Syntax

```
VMOV{cond}.F64 Dd, Dm
```

```
VMOV{cond}.F32 Sd, Sm
```

where:

- ‘*cond*’ is an optional condition code, see [Conditional execution on page 64](#).
- ‘*Dd*’ is the destination register, for a doubleword operation.
- ‘*Dm*’ is the source register, for a doubleword operation.
- ‘*Sd*’ is the destination register, for a singleword operation.
- ‘*Sm*’ is the source register, for a singleword operation.

Operation

This instruction copies the contents of one floating-point register to another.

Restrictions

There are no restrictions

Condition flags

These instructions do not change the flags.

### 3.10.15 VMOV scalar to ARM core register

Transfers one word of a doubleword floating-point register to an ARM core register.

Syntax

```
VMOV{cond} Rt, Dn[x]
```

where:

- ‘*cond*’ is an optional condition code, see [Conditional execution on page 64](#).
- ‘*Rt*’ is the destination ARM core register.
- ‘*Dn*’ is the 64-bit doubleword register.
- ‘*x*’ Specifies which half of the doubleword register to use:  
If *x* is 0, use lower half, if *x* is 1, use upper half.

Operation

This instruction transfers one word from the upper or lower half of a doubleword floating-point register to an ARM core register.

Restrictions

*Rt* cannot be PC or SP.

Condition flags

These instructions do not change the flags.

### 3.10.16 VMOV ARM core register to single precision

Transfers a single-precision register to and from an ARM core register.

Syntax

```
VMOV{cond} Sn, Rt
```

```
VMOV{cond} Rt, Sn
```

where:

- ‘*cond*’ is an optional condition code, see [Conditional execution on page 64](#).
- ‘*Sn*’ is the single-precision floating-point register.
- ‘*Rt*’ is the ARM core register.

Operation

This instruction transfers:

- The contents of a single-precision register to an ARM core register.
- The contents of an ARM core register to a single-precision register.

Restrictions

Rt cannot be PC or SP.

Condition flags

These instructions do not change the flags.



### 3.10.17 VMOV two ARM core registers to two single precision

Transfers two consecutively numbered single-precision registers to and from two ARM core registers.

#### Syntax

```
VMOV{cond} Sm, Sm1, Rt, Rt2
```

```
VMOV{cond} Rt, Rt2, Sm, Sm
```

where:

- ‘*cond*’ is an optional condition code, see [Conditional execution on page 64](#).
- ‘*Sm*’ is the first single-precision register.
- ‘*Sm1*’ is a second single-precision register (the next single-precision register after *Sm*).
- ‘*Rt*’ is the ARM core register that *Sm* is transferred to or from.
- ‘*Rt2*’ is the ARM core register that *Sm1* is transferred to or from.

#### Operation

This instruction transfers:

1. Contents of two consecutively numbered single-precision registers to two ARM core registers.
2. Contents of two ARM core registers to a pair of single-precision registers.

#### Restrictions

The restrictions are:

- The floating-point registers must be contiguous, one after the other.
- The ARM core registers do not have to be contiguous.
- *Rt* cannot be PC or SP.

#### Condition flags

These instructions do not change the flags.

### 3.10.18 VMOV ARM Core register to scalar

Transfers one word to a floating-point register from an ARM core register.

Syntax

```
VMOV{cond}{.32} Dd[x], Rt
```

where:

- '*cond*' is an optional condition code, see [Conditional execution on page 64](#).
- 32 is an optional data size specifier.
- *Dd[x]* is the destination, where [x] defines which half of the doubleword is transferred, as follows:
  - If x is 0, the lower half is extracted
  - If x is 1, the upper half is extracted.
- *Rt* is the source ARM core register.

Operation

This instruction transfers one word to the upper or lower half of a doubleword floating-point register from an ARM core register.

Restrictions

*Rt* cannot be PC or SP.

Condition flags

These instructions do not change the flags.

### 3.10.19 VMRS

Move to ARM Core register from floating-point System Register.

Syntax

```
VMRS{cond} Rt, FPSCR
```

```
VMRS{cond} APSR_nzcv, FPSCR
```

where:

- '*cond*' is an optional condition code, see [Conditional execution on page 64](#).
- '*Rt*' is the destination ARM core register. This register can be R0-R14.
- '*APSR\_nzcv*' Transfer floating-point flags to the APSR flags.

Operation

This instruction performs one of the following actions:

1. Copies the value of the FPSCR to a general-purpose register.
2. Copies the value of the FPSCR flag bits to the APSR N, Z, C, and V flags.

Restrictions

*Rt* cannot be PC or SP.

Condition flags

These instructions optionally change the flags: N, Z, C, V

### 3.10.20 VMSR

Move to floating-point System Register from ARM Core register.

Syntax

```
VMSR{cond} FPSCR, Rt
```

where:

- ‘*cond*’ is an optional condition code, see [Conditional execution on page 64](#).
- ‘*Rt*’ is the general-purpose register to be transferred to the FPSCR.

Operation

This instruction moves the value of a general-purpose register to the FPSCR. See [Floating-point status control register \(FPSCR\) on page 239](#) for more information.

Restrictions

The restrictions are *Rt* cannot be PC or SP.

Condition flags

This instruction updates the FPSCR.

### 3.10.21 VMUL

Floating-point Multiply.

Syntax

```
VMUL{cond}.F32 {Sd,} Sn, Sm
```

where:

- ‘*cond*’ is an optional condition code, see [Conditional execution on page 64](#).
- ‘*Sd*’ is the destination floating-point value
- ‘*Sn, Sm*’ are the operand floating-point values.

Operation

This instruction:

1. Multiplies two floating-point values.
2. Places the results in the destination register.

Restrictions

There are no restrictions.

Condition flags

These instructions do not change the flags.

### 3.10.22 VNEG

Floating-point Negate.

Syntax

VNEG{cond}.F32 Sd, Sm

where:

- ‘cond’ is an optional condition code, see [Conditional execution on page 64](#).
- ‘Sd’ is the destination floating-point value
- ‘Sm’ is the operand floating-point value.

Operation

This instruction:

1. Negates a floating-point value.
2. Places the results in a second floating-point register.
3. The floating-point instruction inverts the sign bit.

Restrictions

There are no restrictions.

Condition flags

These instructions do not change the flags.

### 3.10.23 VNMLA, VNMLS, VNMUL

Floating-point multiply with negation followed by add or subtract.

#### Syntax

VNMLA{cond}.F32 Sd, Sn, Sm

VNMLS{cond}.F32 Sd, Sn, Sm

VNMUL{cond}.F32 {Sd,} Sn, Sm

where:

- ‘cond’ is an optional condition code, see [Conditional execution on page 64](#).
- ‘Sd’ is the destination floating-point value
- ‘Sn, Sm’ are the operand floating-point values.

#### Operation

The VNMLA instruction:

1. Multiplies two floating-point register values.
2. Adds the negation of the floating-point value in the destination register to the negation of the product.
3. Writes the result back to the destination register.

The VNMLS instruction:

1. Multiplies two floating-point register values.
2. Adds the negation of the floating-point value in the destination register to the product.
3. writes the result back to the destination register.

The VNMUL instruction:

1. Multiplies together two floating-point register values.
2. Writes the negation of the result to the destination register.

#### Restrictions

There are no restrictions.

#### Condition flags

These instructions do not change the flags.

### 3.10.24 VPOP

Floating-point extension register Pop.

Syntax

```
VPOP{cond}{.size} list
```

where:

- '*cond*' is an optional condition code, see [Conditional execution on page 64](#).
- '*size*' is an optional data size specifier. If present, it must be equal to the size in bits, 32 or 64, of the registers in list.
- '*list*' is a list of extension registers to be loaded, as a list of consecutively numbered doubleword or singleword registers, separated by commas and surrounded by brackets.

Operation

This instruction loads multiple consecutive extension registers from the stack.

Restrictions

The list must contain at least one register, and not more than sixteen registers.

Condition flags

These instructions do not change the flags.

### 3.10.25 VPUSH

Floating-point extension register Push.

Syntax

```
VPUSH{cond}{.size} list
```

where:

- '*cond*' is an optional condition code, see [Conditional execution on page 64](#).
- '*size*' is an optional data size specifier. If present, it must be equal to the size in bits, 32 or 64, of the registers in list.
- '*list*' is a list of the extension registers to be stored, as a list of consecutively numbered doubleword or singleword registers, separated by commas and surrounded by brackets.

Operation

This instruction stores multiple consecutive extension registers to the stack.

Restrictions

The restrictions are list must contain at least one register, and not more than sixteen.

Condition flags

These instructions do not change the flags.

### 3.10.26 VSQRT

Floating-point Square Root.

Syntax

```
VSQRT{cond}.F32 Sd, Sm
```

where:

- ‘*cond*’ is an optional condition code, see [Conditional execution on page 64](#).
- ‘*Sd*’ is the destination floating-point value
- ‘*Sm*’ is the operand floating-point value.

Operation

This instruction:

1. Calculates the square root of the value in a floating-point register.
2. Writes the result to another floating-point register.

Restrictions

There are no restrictions.

Condition flags

These instructions do not change the flags.

### 3.10.27 VSTM

Floating-point Store Multiple.

Syntax

```
VSTM{mode}{cond}{.size} Rn{!}, list
```

where:

- ‘*mode*’ is the addressing mode:
  - IA Increment After. The consecutive addresses start at the address specified in Rn. This is the default and can be omitted.
  - DB Decrement Before. The consecutive addresses end just before the address specified in Rn.
- ‘*cond*’ is an optional condition code, see [Conditional execution on page 64](#).
- ‘*size*’ is an optional data size specifier. If present, it must be equal to the size in bits, 32 or 64, of the registers in list.
- ‘*Rn*’ is the base register. The SP can be used.
- ‘*!*’ is the function that causes the instruction to write a modified value back to Rn. Required if mode == DB.
- ‘*list*’ is a list of the extension registers to be stored, as a list of consecutively numbered doubleword or singleword registers, separated by commas and surrounded by brackets.

Operation

This instruction stores multiple extension registers to consecutive memory locations using a base address from an ARM core register.

Restrictions

The restrictions are:

- list must contain at least one register.
- If it contains doubleword registers it must not contain more than 16 registers.
- Use of the PC as Rn is deprecated.

Condition flags

These instructions do not change the flags.

### 3.10.28 VSTR

Floating-point Store.

Syntax

VSTR{cond}{.32} Sd, [Rn{, #imm}]

VSTR{cond}{.64} Dd, [Rn{, #imm}]

where:

- '*cond*' is an optional condition code, see [Conditional execution on page 64](#).
- '*32, 64*' are the optional data size specifiers.
- '*Sd*' is the source register for a singleword store.
- '*Dd*' is the source register for a doubleword store.
- '*Rn*' is the base register. The SP can be used.
- '*imm*' is the + or - immediate offset used to form the address. Values are multiples of 4 in the range 0-1020. *imm* can be omitted, meaning an offset of +0.

#### Operation

This instruction stores a single extension register to memory, using an address from an ARM core register, with an optional offset, defined in *imm*.

Restrictions

The restrictions are the use of PC for Rn is deprecated.

#### Condition flags

These instructions do not change the flags.



### 3.10.29 VSUB

Floating-point Subtract.

Syntax

`VSUB{cond}.F32 {Sd,} Sn, Sm`

where:

- ‘*cond*’ is an optional condition code, see [Conditional execution on page 64](#).
- ‘*Sd*’ is the destination floating-point value
- ‘*Sn, Sm*’ are the operand floating-point values.

#### Operation

This instruction:

1. Subtracts one floating-point value from another floating-point value.
2. Places the results in the destination floating-point register.

Restrictions

There are no restrictions.

#### Condition flags

These instructions do not change the flags.

## 3.11 Miscellaneous instructions

[Table 36](#) shows the remaining Cortex-M4 instructions:

**Table 36. Miscellaneous instructions**

Mnemonic	Brief description	See
BKPT	Breakpoint	<a href="#">BKPT on page 170</a>
CPSID	Change Processor State, Disable Interrupts	<a href="#">CPS on page 171</a>
CPSIE	Change Processor State, Enable Interrupts	<a href="#">CPS on page 171</a>
DMB	Data Memory Barrier	<a href="#">DMB on page 172</a>
DSB	Data Synchronization Barrier	<a href="#">DSB on page 172</a>
ISB	Instruction Synchronization Barrier	<a href="#">ISB on page 173</a>
MRS	Move from special register to register	<a href="#">MRS on page 173</a>
MSR	Move from register to special register	<a href="#">MSR on page 174</a>
NOP	No Operation	<a href="#">NOP on page 175</a>
SEV	Send Event	<a href="#">SEV on page 175</a>
SVC	Supervisor Call	<a href="#">SVC on page 176</a>
WFE	Wait For Event	<a href="#">WFE on page 176</a>
WFI	Wait For Interrupt	<a href="#">WFI on page 177</a>

### 3.11.1 BKPT

Breakpoint.

#### Syntax

BKPT #*imm*

where:

- '*imm*' is an expression evaluating to an integer in the range 0-255 (8-bit value).

#### Operation

The BKPT instruction causes the processor to enter Debug state. Debug tools can use this to investigate system state when the instruction at a particular address is reached.

*imm* is ignored by the processor. If required, a debugger can use it to store additional information about the breakpoint.

The BKPT instruction can be placed inside an IT block, but it executes unconditionally, unaffected by the condition specified by the IT instruction.

#### Condition flags

This instruction does not change the flags.

## Examples

```
BKPT 0xAB ; Breakpoint with immediate value set to 0xAB (debugger can
; extract the immediate value by locating it using the PC)
```

### 3.11.2 CPS

Change processor state.

#### Syntax

```
CPSeffect iflags
```

where:

- *'effect'* is one of:
  - IE: Clears the special purpose register.
  - ID: Sets the special purpose register.
- *'iflags'* is a sequence of one or more flags:
  - i: Set or clear PRIMASK.
  - f: Set or clear FAULTMASK.

#### Operation

CPS changes the PRIMASK and FAULTMASK special register values. See [Exception mask registers on page 22](#) for more information about these registers.

#### Restrictions

The restrictions are:

- Use CPS only from privileged software, it has no effect if used in unprivileged software
- CPS cannot be conditional and so must not be used inside an IT block.

#### Condition flags

This instruction does not change the condition flags.

#### Examples

```
CPSID i ; Disable interrupts and configurable fault handlers (set PRIMASK)
CPSID f ; Disable interrupts and all fault handlers (set FAULTMASK)
CPSIE i ; Enable interrupts and configurable fault handlers (clear PRIMASK)
CPSIE f ; Enable interrupts and fault handlers (clear FAULTMASK)
```

### 3.11.3 DMB

Data memory barrier.

#### Syntax

```
DMB{ cond }
```

where: '*cond*' is an optional condition code, see [Conditional execution on page 64](#).

#### Operation

DMB acts as a data memory barrier. It ensures that all explicit memory accesses that appear, in program order, before the DMB instruction are completed before any explicit memory accesses that appear, in program order, after the DMB instruction. DMB does not affect the ordering or execution of instructions that do not access memory.

#### Condition flags

This instruction does not change the flags.

#### Examples

```
DMB ; Data Memory Barrier
```

### 3.11.4 DSB

Data synchronization barrier.

#### Syntax

```
DSB{ cond }
```

where: '*cond*' is an optional condition code, see [Conditional execution on page 64](#).

#### Operation

DSB acts as a special data synchronization memory barrier. Instructions that come after the DSB, in program order, do not execute until the DSB instruction completes. The DSB instruction completes when all explicit memory accesses before it complete.

#### Condition flags

This instruction does not change the flags.

#### Examples

```
DSB ; Data Synchronisation Barrier
```

### 3.11.5 ISB

Instruction synchronization barrier.

#### Syntax

`ISB{ cond }`

where: '*cond*' is an optional condition code, see [Conditional execution on page 64](#).

#### Operation

ISB acts as an instruction synchronization barrier. It flushes the pipeline of the processor, so that all instructions following the ISB are fetched from cache or memory again, after the ISB instruction has been completed.

#### Condition flags

This instruction does not change the flags.

#### Examples

```
ISB ; Instruction Synchronisation Barrier
```

### 3.11.6 MRS

Move the contents of a special register to a general-purpose register.

#### Syntax

`MRS{ cond } Rd, spec_reg`

where:

- '*cond*' is an optional condition code, see [Conditional execution on page 64](#).
- '*Rd*' is the destination register.
- '*spec\_reg*' can be any of: APSR, IPSR, EPSR, IEPSR, IAPSR, EAPSR, PSR, MSP, PSP, PRIMASK, BASEPRI, BASEPRI\_MAX, FAULTMASK, or CONTROL.

#### Operation

Use MRS in combination with MSR as part of a read-modify-write sequence for updating a PSR, for example to clear the Q flag. See [MSR on page 174](#).

In process swap code, the programmers model state of the process being swapped out must be saved, including relevant PSR contents. Similarly, the state of the process being swapped in must also be restored. These operations use MRS in the state-saving instruction sequence and MSR in the state-restoring instruction sequence.

BASEPRI\_MAX is an alias of BASEPRI when used with the MRS instruction.

#### Restrictions

*Rd* must not be SP and must not be PC.

#### Condition flags

This instruction does not change the flags.

#### Examples

```
MRS R0, PRIMASK ; Read PRIMASK value and write it to R0
```

### 3.11.7 MSR

Move the contents of a general-purpose register into the specified special register.

#### Syntax

```
MSR{cond} spec_reg, Rn
```

where:

- '*cond*' is an optional condition code, see [Conditional execution on page 64](#).
- '*Rn*' is the source register.
- '*spec\_reg*' can be any of: APSR, IPSR, EPSR, IEPSR, IAPSR, EAPSR, PSR, MSP, PSP, PRIMASK, BASEPRI, BASEPRI\_MAX, FAULTMASK, or CONTROL.

#### Operation

The register access operation in MSR depends on the privilege level. Unprivileged software can only access the APSR, see [Table 5: APSR bit definitions on page 20](#). Privileged software can access all special registers.

In unprivileged software writes to unallocated or execution state bits in the PSR are ignored.

When you write to BASEPRI\_MAX, the instruction writes to BASEPRI only if either:

- *Rn* is non-zero and the current BASEPRI value is 0
- *Rn* is non-zero and less than the current BASEPRI value.

See [MRS on page 173](#).

#### Restrictions

*Rn* must not be SP and must not be PC.

Condition flags

This instruction updates the flags explicitly based on the value in *Rn*.

#### Examples

```
MSR CONTROL, R1 ; Read R1 value and write it to the CONTROL register
```

### 3.11.8 NOP

No Operation.

#### Syntax

```
NOP{cond}
```

where:

- 'cond' is an optional condition code, see [Conditional execution on page 64](#).

#### Operation

NOP does nothing. NOP is not necessarily a time-consuming NOP. The processor might remove it from the pipeline before it reaches the execution stage.

Use NOP for padding, for example to place the following instruction on a 64-bit boundary.

#### Condition flags

This instruction does not change the flags.

#### Examples

```
NOP ; No operation
```

### 3.11.9 SEV

Send Event.

#### Syntax

```
SEV{cond}
```

where:

- 'cond' is an optional condition code, see [Conditional execution on page 64](#).

#### Operation

SEV is a hint instruction that causes an event to be signaled to all processors within a multiprocessor system. It also sets the local event register to 1, see [Power management on page 46](#).

#### Condition flags

This instruction does not change the flags.

#### Examples

```
SEV ; Send Event
```

### 3.11.10 SVC

Supervisor Call.

#### Syntax

```
SVC{cond} #imm
```

where:

- ‘cond’ is an optional condition code, see [Conditional execution on page 64](#).
- ‘imm’ is an expression evaluating to an integer in the range 0-255 (8-bit value).

#### Operation

The SVC instruction causes the SVC exception. *imm* is ignored by the processor. If required, it can be retrieved by the exception handler to determine what service is being requested.

#### Condition flags

This instruction does not change the flags.

#### Examples

```
SVC 0x32 ; Supervisor Call (SVC handler can extract the immediate  
value  
; by locating it via the stacked PC)
```

### 3.11.11 WFE

Wait For Event. WFE is a hint instruction.

#### Syntax

```
WFE{cond}
```

where: ‘cond’ is an optional condition code, see [Conditional execution on page 64](#).

#### Operation

If the event register is 0, WFE suspends execution until one of the following events occurs:

- An exception, unless masked by exception mask registers or the current priority level
- An exception enters Pending state, if SEVONPEND in System Control Register is set
- A Debug Entry request, if Debug is enabled
- An event signaled by a peripheral or another processor in a multiprocessor system using the SEV instruction.

If the event register is 1, WFE clears it to 0 and returns immediately.

For more information see [Power management on page 46](#).

#### Condition flags

This instruction does not change the flags.

#### Examples

```
WFE ; Wait for event
```



### 3.11.12 WFI

Wait for Interrupt.

#### Syntax

WFI{*cond*}

where:

- '*cond*' is an optional condition code, see [Conditional execution on page 64](#).

#### Operation

WFI is a hint instruction that suspends execution until one of the following events occurs:

- An exception
- A Debug Entry request, regardless of whether Debug is enabled.

#### Condition flags

This instruction does not change the flags.

#### Examples

```
WFI ; Wait for interrupt
```

## 4 Core peripherals

### 4.1 About the STM32 Cortex-M4 core peripherals

The address map of the *Private peripheral bus* (PPB) is:

**Table 37. STM32 core peripheral register regions**

Address	Core peripheral	Description
0xE000E010-0xE000E01F	System timer	<a href="#">Table 55 on page 235</a>
0xE000E100-0xE000E4EF	Nested vectored interrupt controller	<a href="#">Table 49 on page 204</a>
0xE000ED00-0xE000ED3F	System control block	<a href="#">Table 53 on page 228</a>
0xE000ED88-0xE000ED8B	Floating point unit coprocessor access control	<a href="#">Table 56 on page 236</a>
0xE000ED90-0xE000EDB8	Memory protection unit	<a href="#">Table 44 on page 191</a>
0xE000EF00-0xE000EF03	Nested vectored interrupt controller	<a href="#">Table 49 on page 204</a>
0xE000EF30-0xE000EF44	Floating point unit	<a href="#">Table 56 on page 236</a>

In register descriptions,

- Register type is described as follows:
  - RW: Read and write.
  - RO: Read-only.
  - WO: Write-only.
- *Required privilege* gives the privilege level required to access the register, as follows:
  - Privileged: Only privileged software can access the register.
  - Unprivileged: Both unprivileged and privileged software can access the register.

### 4.2 Memory protection unit (MPU)

This section describes the Memory protection unit (MPU) which is implemented in some STM32 microcontrollers. Refer to the corresponding device datasheet to see if the MPU is present in the STM32 type you are using.

The MPU divides the memory map into a number of regions, and defines the location, size, access permissions, and memory attributes of each region. It supports:

- Independent attribute settings for each region
- Overlapping regions
- Export of memory attributes to the system.

The memory attributes affect the behavior of memory accesses to the region. The Cortex-M4 MPU defines:

- Eight separate memory regions, 0-7
- A background region.

When memory regions overlap, a memory access is affected by the attributes of the region with the highest number. For example, the attributes for region 7 take precedence over the attributes of any region that overlaps region 7.

The background region has the same memory access attributes as the default memory map, but is accessible from privileged software only.

The Cortex-M4 MPU memory map is unified. This means instruction accesses and data accesses have same region settings.

If a program accesses a memory location that is prohibited by the MPU, the processor generates a memory management fault. This causes a fault exception, and might cause termination of the process in an OS environment.

In an OS environment, the kernel can update the MPU region setting dynamically based on the process to be executed. Typically, an embedded OS uses the MPU for memory protection.

Configuration of MPU regions is based on memory types, see [Section 2.2.1: Memory regions, types and attributes on page 28](#).

[Table 38](#) shows the possible MPU region attributes.

**Table 38. Memory attributes summary**

Memory type	Shareability	Other attributes	Description
Strongly-ordered	-	-	All accesses to Strongly-ordered memory occur in program order. All Strongly-ordered regions are assumed to be shared.
Device	Shared	-	Memory-mapped peripherals that several processors share.
	Non-shared	-	Memory-mapped peripherals that only a single processor uses.
Normal	Shared	Non-cacheable Write-through Cacheable Write-back Cacheable	Normal memory that is shared between several processors.
	Non-shared	Non-cacheable Write-through Cacheable Write-back Cacheable	Normal memory that only a single processor uses.

### 4.2.1 MPU access permission attributes

This section describes the MPU access permission attributes. The access permission bits, TEX, C, B, S, AP, and XN, of the MPU\_RASR register, control access to the corresponding memory region. If an access is made to an area of memory without the required permissions, then the MPU generates a permission fault.

Table 39 shows the encodings for the TEX, C, B, and S access permission bits.

**Table 39. TEX, C, B, and S encoding**

TEX	C	B	S	Memory type	Shareability	Other attributes
b000	0	0	x <sup>(1)</sup>	Strongly-ordered	Shareable	-
		1	x <sup>(1)</sup>	Device	Shareable	-
	1	0	0	Normal	Not shareable	Outer and inner write-through. No write allocate.
			1		Shareable	
		1	0	Normal	Not shareable	Outer and inner write-back. No write allocate.
			1		Shareable	
b001	0	0	Normal	Not shareable	Outer and inner noncacheable.	
				1		Shareable
		1	x <sup>(1)</sup>	Reserved encoding		-
	1	0	x <sup>(1)</sup>	Implementation defined attributes.		-
		1	0	Normal	Not shareable	Outer and inner write-back. Write and read allocate.
			1		Shareable	
b010	0	0	x <sup>(1)</sup>	Device	Not shareable	Nonshared Device.
		1	x <sup>(1)</sup>	Reserved encoding		-
	1	x <sup>(1)</sup>		Reserved encoding		-
		A	A	0	Normal	Not shareable
1	Shareable					

1. The MPU ignores the value for this bit.
2. See Table 40 for the encoding of the AA and BB bits.

Table 40 shows the cache policy for memory attribute encodings with a TEX value is in the range 4-7.

**Table 40. Cache policy for memory attribute encoding**

Encoding, AA or BB	Corresponding cache policy
00	Non-cacheable
01	Write back, write and read allocate
10	Write through, no write allocate
11	Write back, no write allocate

Table 41 shows the AP encodings that define the access permissions for privileged and unprivileged software.

**Table 41. AP encoding**

AP[2:0]	Privileged permissions	Unprivileged permissions	Description
000	No access	No access	All accesses generate a permission fault
001	RW	No access	Access from privileged software only
010	RW	RO	Writes by unprivileged software generate a permission fault
011	RW	RW	Full access
100	Unpredictable	Unpredictable	Reserved
101	RO	No access	Reads by privileged software only
110	RO	RO	Read only, by privileged or unprivileged software
111	RO	RO	Read only, by privileged or unprivileged software

### 4.2.2 MPU mismatch

When an access violates the MPU permissions, the processor generates a memory management fault, see [Section 2.1.4: Exceptions and interrupts on page 25](#). The MMFSR indicates the cause of the fault. See [Section 4.4.15: Memory management fault address register \(MMFAR\) on page 226](#) for more information.

### 4.2.3 Updating an MPU region

To update the attributes for an MPU region, update the MPU\_RNR, MPU\_RBAR and MPU\_RASR registers. You can program each register separately, or use a multiple-word write to program all of these registers. You can use the MPU\_RBAR and MPU\_RASR aliases to program up to four regions simultaneously using an STM instruction.

Updating an MPU region using separate words

Simple code to configure one region:

```

; R1 = region number
; R2 = size/enable
; R3 = attributes
; R4 = address
LDR R0,=MPU_RNR ; 0xE000ED98, MPU region number register
STR R1, [R0, #0x0] ; Region Number
STR R4, [R0, #0x4] ; Region Base Address
STRH R2, [R0, #0x8] ; Region Size and Enable
STRH R3, [R0, #0xA] ; Region Attribute
    
```

Disable a region before writing new region settings to the MPU if you have previously enabled the region being changed. For example:

```

; R1 = region number
    
```

```

; R2 = size/enable
; R3 = attributes
; R4 = address
LDR R0, =MPU_RNR      ; 0xE000ED98, MPU region number register
STR R1, [R0, #0x0]    ; Region Number
BIC R2, R2, #1        ; Disable
STRH R2, [R0, #0x8]   ; Region Size and Enable
STR R4, [R0, #0x4]    ; Region Base Address
STRH R3, [R0, #0xA]   ; Region Attribute
ORR R2, #1            ; Enable
STRH R2, [R0, #0x8]   ; Region Size and Enable

```

Software must use memory barrier instructions:

- Before MPU setup if there might be outstanding memory transfers, such as buffered writes, that might be affected by the change in MPU settings
- After MPU setup if it includes memory transfers that must use the new MPU settings.

However, memory barrier instructions are not required if the MPU setup process starts by entering an exception handler, or is followed by an exception return, because the exception entry and exception return mechanism cause memory barrier behavior.

Software does not need any memory barrier instructions during MPU setup, because it accesses the MPU through the PPB, which is a Strongly-Ordered memory region.

For example, if you want all of the memory access behavior to take effect immediately after the programming sequence, use a DSB instruction and an ISB instruction:

- A DSB is required after changing MPU settings, such as at the end of context switch.
- An ISB is required if the code that programs the MPU region or regions is entered using a branch or call. If the programming sequence is entered using a return from exception, or by taking an exception, then you do not require an ISB.

### Updating an MPU region using multi-word writes

You can program directly using multi-word writes, depending on how the information is divided. Consider the following reprogramming:

```

; R1 = region number
; R2 = address
; R3 = size, attributes in one
LDR R0, =MPU_RNR      ; 0xE000ED98, MPU region number register
STR R1, [R0, #0x0]    ; Region Number
STR R2, [R0, #0x4]    ; Region Base Address
STR R3, [R0, #0x8]    ; Region Attribute, Size and Enable

```

Use an STM instruction to optimize this:

```

; R1 = region number
; R2 = address
; R3 = size, attributes in one
LDR R0, =MPU_RNR      ; 0xE000ED98, MPU region number register
STM R0, {R1-R3}       ; Region Number, address, attribute, size and enable

```

You can do this in two words for pre-packed information. This means that the RBAR contains the required region number and had the VALID bit set to 1, see [MPU region base address register \(MPU\\_RBAR\) on page 188](#). Use this when the data is statically packed, for example in a boot loader:

```

; R1 = address and region number in one
; R2 = size and attributes in one
LDR R0, =MPU_RBAR ; 0xE000ED9C, MPU Region Base register
STR R1, [R0, #0x0] ; Region base address and
; region number combined with VALID (bit 4) set to 1
STR R2, [R0, #0x4] ; Region Attribute, Size and Enable
    
```

Use an STM instruction to optimize this:

```

; R1 = address and region number in one
; R2 = size and attributes in one
LDR R0, =MPU_RBAR ; 0xE000ED9C, MPU Region Base register
STM R0, {R1-R2} ; Region base address, region number and VALID bit,
; and Region Attribute, Size and Enable
    
```

### Subregions

Regions of 256 bytes or more are divided into eight equal-sized subregions. Set the corresponding bit in the SRD field of the RASR to disable a subregion, see [Section 4.2.9: MPU region attribute and size register \(MPU\\_RASR\) on page 189](#). The least significant bit of SRD controls the first subregion, and the most significant bit controls the last subregion. Disabling a subregion means another region overlapping the disabled range matches instead. If no other enabled region overlaps the disabled subregion the MPU issues a fault.

Regions of 32, 64, and 128 bytes do not support subregions, With regions of these sizes, you must set the SRD field to 0x00, otherwise the MPU behavior is Unpredictable.

Example of SRD use:

Two regions with the same base address overlap. Region one is 128KB, and region two is 512KB. To ensure the attributes from region one apply to the first 128KB region, set the SRD field for region two to b0000011 to disable the first two subregions, as the figure shows.

Figure 18. Subregion example

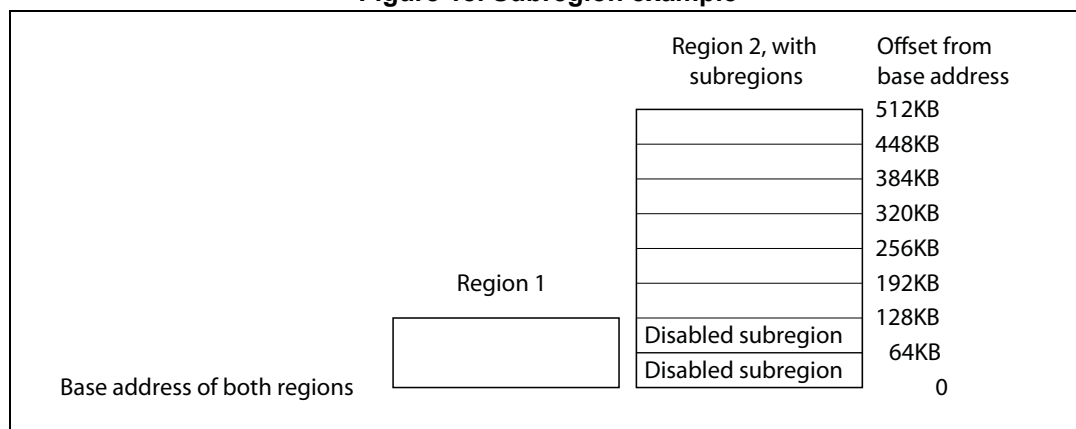

#### 4.2.4 MPU design hints and tips

To avoid unexpected behavior, disable the interrupts before updating the attributes of a region that the interrupt handlers might access.

Ensure software uses aligned accesses of the correct size to access MPU registers:

- Except for the RASR, it must use aligned word accesses
- For the RASR it can use byte or aligned halfword or word accesses.

The processor does not support unaligned accesses to MPU registers.

When setting up the MPU, and if the MPU has previously been programmed, disable unused regions to prevent any previous region settings from affecting the new MPU setup.

#### Recommended MPU configuration

The STM32 microcontroller system has only a single processor, so you should program the MPU as follows:

**Table 42. Memory region attributes for STM32**

Memory region	TEX	C	B	S	Memory type and attributes
Flash memory	b000	1	0	0	Normal memory, Non-shareable, write-through
Internal SRAM	b000	1	0	1	Normal memory, Shareable, write-through
External SRAM	b000	1	1	1	Normal memory, Shareable, write-back, write-allocate
Peripherals	b000	0	1	1	Device memory, Shareable

In STM32 implementations, the shareability and cache policy attributes do not affect the system behavior. However, using these settings for the MPU regions can make the application code more portable. The values given are for typical situations.

*Note:* The MPU attributes don't affect DMA data accesses to the memory/peripherals address spaces. therefore, in order to protect the memory areas against inadvertent DMA accesses, the MPU must control the SW/CPU access to the DMA registers.



### 4.2.5 MPU type register (MPU\_TYPER)

Address offset: 0x00

Reset value: 0x0000 0800

Required privilege: Privileged

The MPU\_TYPER register indicates whether the MPU is present, and if so, how many regions it supports.

31	30	29	28	27	26	25	24	23	22	21	20	19	18	17	16
Reserved								IREGION[7:0]							
								r	r	r	r	r	r	r	r
15	14	13	12	11	10	9	8	7	6	5	4	3	2	1	0
DREGION[7:0]								Reserved							SEPA RATE
r	r	r	r	r	r	r									r

Bits 31:24 **Reserved.**

Bits 23:16 **IREGION[7:0]:** Number of MPU instruction regions.

These bits indicates the number of supported MPU instruction regions.

Always contains 0x00. The MPU memory map is unified and is described by the DREGION field.

Bits 15:8 **DREGION[7:0]:** Number of MPU data regions.

These bits indicates the number of supported MPU data regions.

0x08: Eight MPU regions

0x00: MPU not present

Bits 7:1 **Reserved.**

Bit 0 **SEPARATE:** Separate flag.

This bit indicates support for unified or separate instruction and data memory maps:

0 = Unified

1 = Separate

### 4.2.6 MPU control register (MPU\_CTRL)

Address offset: 0x04

Reset value: 0x0000 0000

Required privilege: Privileged

The MPU\_CTRL register:

- Enables the MPU
- Enables the default memory map background region
- Enables use of the MPU when in the hard fault, Non-maskable Interrupt (NMI), and FAULTMASK escalated handlers.

When ENABLE and PRIVDEFENA are both set to 1:

- For privileged accesses, the default memory map is as described in [Section 2.2: Memory model on page 27](#). Any access by privileged software that does not address an enabled memory region behaves as defined by the default memory map.
- Any access by unprivileged software that does not address an enabled memory region causes a memory management fault.

XN and Strongly-ordered rules always apply to the System Control Space regardless of the value of the ENABLE bit.

When the ENABLE bit is set to 1, at least one region of the memory map must be enabled for the system to function unless the PRIVDEFENA bit is set to 1. If the PRIVDEFENA bit is set to 1 and no regions are enabled, then only privileged software can operate.

When the ENABLE bit is set to 0, the system uses the default memory map. This has the same memory attributes as if the MPU is not implemented, see [Table 13: Memory access behavior on page 29](#). The default memory map applies to accesses from both privileged and unprivileged software.

When the MPU is enabled, accesses to the System Control Space and vector table are always permitted. Other areas are accessible based on regions and whether PRIVDEFENA is set to 1.

Unless HFNMIENA is set to 1, the MPU is not enabled when the processor is executing the handler for an exception with priority -1 or -2. These priorities are only possible when handling a hard fault or NMI exception, or when FAULTMASK is enabled. Setting the HFNMIENA bit to 1 enables the MPU when operating with these two priorities.

31	30	29	28	27	26	25	24	23	22	21	20	19	18	17	16
Reserved															
15	14	13	12	11	10	9	8	7	6	5	4	3	2	1	0
Reserved													PRIVDEFENA	HFNMIENA	EN ABLE
													rw	rw	rw

Bits 31:3 **Reserved, forced by hardware to 0.**

Bit 2 **PRIVDEFENA**: Enable privileged software access to default memory map.  
 0: If the MPU is enabled, disables use of the default memory map. Any memory access to a location not covered by any enabled region causes a fault.  
 1: If the MPU is enabled, enables use of the default memory map as a background region for privileged software accesses.

*Note: When enabled, the background region acts as if it is region number -1. Any region that is defined and enabled has priority over this default map. If the MPU is disabled, the processor ignores this bit.*

Bit 1 **HFNMENA**: Enables the operation of MPU during hard fault, NMI, and FAULTMASK handlers. When the MPU is enabled:  
 0: MPU is disabled during hard fault, NMI, and FAULTMASK handlers, regardless of the value of the ENABLE bit  
 1: The MPU is enabled during hard fault, NMI, and FAULTMASK handlers.

*Note: When the MPU is disabled, if this bit is set to 1 the behavior is unpredictable.*

Bit 0 **ENABLE**: Enables the MPU  
 0: MPU disabled  
 1: MPU enabled

### 4.2.7 MPU region number register (MPU\_RNR)

Address offset: 0x08

Reset value: 0x0000 0000

Required privilege: Privileged

The MPU\_RNR register selects which memory region is referenced by the MPU\_RBAR and MPU\_RASR registers.

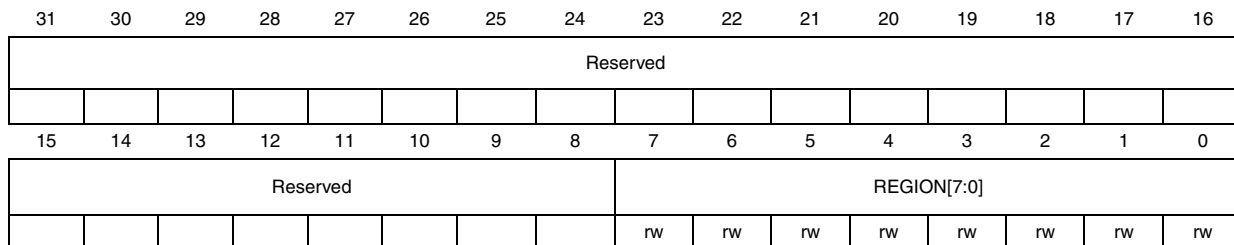

Bits 31:8 **Reserved, forced by hardware to 0.**

Bits 7:0 **REGION[7:0]**: MPU region  
 These bits indicate the MPU region referenced by the MPU\_RBAR and MPU\_RASR registers. The MPU supports 8 memory regions, so the permitted values of this field are 0-7.  
 Normally, you write the required region number to this register before accessing the MPU\_RBAR or MPU\_RASR. However you can change the region number by writing to the MPU\_RBAR register with the VALID bit set to 1, see [MPU region base address register \(MPU\\_RBAR\)](#). This write updates the value of the REGION field.



### 4.2.8 MPU region base address register (MPU\_RBAR)

Address offset: 0x0C

Reset value: 0x0000 0000

Required privilege: Privileged

The MPU\_RBAR register defines the base address of the MPU region selected by the MPU\_RNR register, and can update the value of the MPU\_RNR register.

Write to the MPU\_RBAR register with the VALID bit set to 1 to change the current region number and update the MPU\_RNR register.

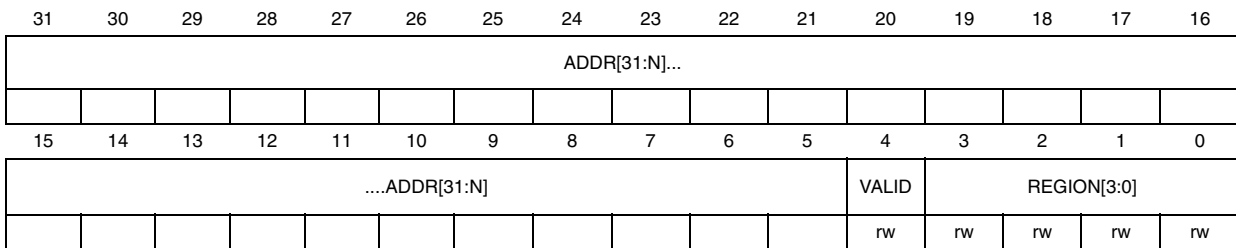

Bits 31:N **ADDR[31:N]**: Region base address field

The value of N depends on the region size.

The region size, as specified by the SIZE field in the MPU\_RASR, defines the value of N:

$$N = \text{Log}_2(\text{Region size in bytes}),$$

If the region size is configured to 4 GB, in the MPU\_RASR register, there is no valid ADDR field. In this case, the region occupies the complete memory map, and the base address is 0x00000000.

The base address is aligned to the size of the region. For example, a 64 KB region must be aligned on a multiple of 64 KB, for example, at 0x00010000 or 0x00020000.

Bits N-1:5 **Reserved, forced by hardware to 0.**

Bit 4 **VALID**: MPU region number valid

**Write:**

0: MPU\_RNR register not changed, and the processor:

- Updates the base address for the region specified in the MPU\_RNR
- Ignores the value of the REGION field

1: the processor:

- updates the value of the MPU\_RNR to the value of the REGION field
- updates the base address for the region specified in the REGION field.

**Read:**

Always read as zero.

Bits 3:0 **REGION[3:0]**: MPU region field

For the behavior on writes, see the description of the VALID field.

On reads, returns the current region number, as specified by the MPU\_RNR register.

### 4.2.9 MPU region attribute and size register (MPU\_RASR)

Address offset: 0x10

Reset value: 0x0000 0000

Required privilege: Privileged

The MPU\_RASR register defines the region size and memory attributes of the MPU region specified by the MPU\_RNR, and enables that region and any subregions.

MPU\_RASR is accessible using word or halfword accesses:

- The most significant halfword holds the region attributes
- The least significant halfword holds the region size and the region and subregion enable bits.

31	30	29	28	27	26	25	24	23	22	21	20	19	18	17	16
Reserved			XN	Reserved	AP[2:0]			Reserved		TEX[2:0]			S	C	B
			rw		rw	rw	rw			rw	rw	rw	rw	rw	rw
15	14	13	12	11	10	9	8	7	6	5	4	3	2	1	0
SRD[7:0]								Reserved		SIZE					ENABLE
rw	rw	rw	rw	rw	rw	rw	rw			rw	rw	rw	rw	rw	rw

Bits 31:29 **Reserved, forced by hardware to 0.**

Bit 28 **XN**: Instruction access disable bit:  
 0: Instruction fetches enabled  
 1: Instruction fetches disabled.

Bit 27 **Reserved, forced by hardware to 0.**

Bits 26:24 **AP[2:0]**: Access permission

For information about access permission, see [Section 4: Core peripherals](#)  
 For a description of AP bits encoding refer to [Table 41 on page 181](#).

Bits 23:22 **Reserved, forced by hardware to 0.**

Bits 21:19 **TEX[2:0]: memory attribute**

For a description of TEX bits encoding refer to [Table 39 on page 180](#)

Bit 18 **S: Shareable memory attribute**

For a description of S bits encoding refer to [Table 39 on page 180](#)

Bit 17 **C: memory attribute**

Bit 16 **B: memory attribute**

Bits 15:8 **SRD**: Subregion disable bits.

For each bit in this field:

- 0: corresponding sub-region is enabled
- 1: corresponding sub-region is disabled

See [Subregions on page 183](#) for more information.

Region sizes of 128 bytes and less do not support subregions. When writing the attributes for such a region, write the SRD field as 0x00.

Bits 7:6 **Reserved, forced by hardware to 0.**

Bits 5:1 **SIZE**: Size of the MPU protection region.

The minimum permitted value is 3 (b00010), see [SIZE field values](#) for more information.

Bit 0 **ENABLE**: Region enable bit.

### SIZE field values

The SIZE field defines the size of the MPU memory region specified by the MPU\_RNR register as follows:

$$(\text{Region size in bytes}) = 2^{(\text{SIZE}+1)}$$

The smallest permitted region size is 32B, corresponding to a SIZE value of 4. [Table 43](#) gives example SIZE values, with the corresponding region size and value of N in the MPU\_RBAR.

**Table 43. Example SIZE field values**

SIZE value	Region size	Value of N <sup>(1)</sup>	Note
b00100 (4)	32B	5	Minimum permitted size
b01001 (9)	1KB	10	-
b10011 (19)	1MB	20	-
b11101 (29)	1GB	30	-
b11111 (31)	4GB	b01100	Maximum possible size

1. In the MPU\_RBAR register see [Section 4.2.8 on page 188](#)

4.2.10 MPU register map

Table 44. MPU register map and reset values

Offset	Register	31	30	29	28	27	26	25	24	23	22	21	20	19	18	17	16	15	14	13	12	11	10	9	8	7	6	5	4	3	2	1	0
0x00	MPU_TYPER	Reserved								IREGION[7:0]							DREGION[7:0]							Reserved					SEPARATE				
	Reset Value	0	0	0	0	0	0	0	0	0	0	0	0	0	0	0	0	0	0	0	1	0	0	0	0	0	0	0	0	0	0	0	0
0x04	MPU_CTRL	Reserved																										PRIVDEFENA	HFNMIEENA	ENABLE			
	Reset Value	0	0	0	0	0	0	0	0	0	0	0	0	0	0	0	0	0	0	0	0	0	0	0	0	0	0	0	0	0	0	0	0
0x08	MPU_RNR	Reserved																							REGION[7:0]								
	Reset Value	0	0	0	0	0	0	0	0	0	0	0	0	0	0	0	0	0	0	0	0	0	0	0	0	0	0	0	0	0	0	0	0
0x0C	MPU_RBAR	ADDR[31:N]...																										VALID	REGION[3:0]				
	Reset Value	0	0	0	0	0	0	0	0	0	0	0	0	0	0	0	0	0	0	0	0	0	0	0	0	0	0	0	0	0	0	0	0
0x10	MPU_RASR	Reserved	XN	Reserved	AP[2:0]	Reserved	TEX[2:0]	S	C	B	SRD[7:0]							Reserved	SIZE	ENABLE													
	Reset Value	0	0	0	0	0	0	0	0	0	0	0	0	0	0	0	0	0	0	0	0	0	0	0	0	0	0	0	0	0	0	0	
0x14	MPU_RBAR_A1 <sup>(1)</sup>	ADDR[31:N]...																										VALID	REGION[3:0]				
	Reset Value	0	0	0	0	0	0	0	0	0	0	0	0	0	0	0	0	0	0	0	0	0	0	0	0	0	0	0	0	0	0	0	0
0x18	MPU_RASR_A1 <sup>(2)</sup>	Reserved	XN	Reserved	AP[2:0]	Reserved	TEX[2:0]	S	C	B	SRD[7:0]							Reserved	SIZE	ENABLE													
	Reset Value	0	0	0	0	0	0	0	0	0	0	0	0	0	0	0	0	0	0	0	0	0	0	0	0	0	0	0	0	0	0	0	0
0x1C	MPU_RBAR_A2 <sup>(1)</sup>	ADDR[31:N]...																										VALID	REGION[3:0]				
	Reset Value	0	0	0	0	0	0	0	0	0	0	0	0	0	0	0	0	0	0	0	0	0	0	0	0	0	0	0	0	0	0	0	0
0x20	MPU_RASR_A2 <sup>(2)</sup>	Reserved	XN	Reserved	AP[2:0]	Reserved	TEX[2:0]	S	C	B	SRD[7:0]							Reserved	SIZE	ENABLE													
	Reset Value	0	0	0	0	0	0	0	0	0	0	0	0	0	0	0	0	0	0	0	0	0	0	0	0	0	0	0	0	0	0	0	0



Table 44. MPU register map and reset values (continued)

Offset	Register	31	30	29	28	27	26	25	24	23	22	21	20	19	18	17	16	15	14	13	12	11	10	9	8	7	6	5	4	3	2	1	0
0x1C	MPU_RBAR_A3 <sup>(1)</sup>	ADDR[31:N]...																												VALID	REGION[3:0]		
	Reset Value	0	0	0	0	0	0	0	0	0	0	0	0	0	0	0	0	0	0	0	0	0	0	0	0	0	0	0	0	0	0	0	0
0x20	MPU_RASR_A3 <sup>(2)</sup>	Reserved		XN	Reserved		AP[2:0]		Reserved		TEX[2:0]		S	C	B	SRD[7:0]							Reserved		SIZE			EN	ABLE				
	Reset Value	0	0	0	0	0	0	0	0	0	0	0	0	0	0	0	0	0	0	0	0	0	0	0	0	0	0	0	0	0	0	0	0

- 1. Alias of MPU\_RBAR register
- 2. Alias of MPU\_RASR register





### 4.3 Nested vectored interrupt controller (NVIC)

This section describes the Nested Vectored Interrupt Controller (NVIC) and the registers it uses. The NVIC supports:

- Up to 81 interrupts (interrupt number depends on the STM32 device type; refer to the datasheets)
- A programmable priority level of 0-15 for each interrupt. A higher level corresponds to a lower priority, so level 0 is the highest interrupt priority
- Level and pulse detection of interrupt signals
- Dynamic reprioritization of interrupts
- Grouping of priority values into group priority and subpriority fields
- Interrupt tail-chaining
- An external *Non-maskable interrupt* (NMI)

The processor automatically stacks its state on exception entry and unstacks this state on exception exit, with no instruction overhead. This provides low latency exception handling. The hardware implementation of the NVIC registers is:

**Table 45. NVIC register summary**

Address	Name	Type	Required privilege	Reset value	Description
0xE00E100-0xE00E10B	NVIC_ISER0-NVIC_ISER2	RW	Privileged	0x00000000	<a href="#">Table 4.3.2: Interrupt set-enable registers (NVIC_ISERx) on page 195</a>
0xE00E180-0xE00E18B	NVIC_ICER0-NVIC_ICER2	RW	Privileged	0x00000000	<a href="#">Table 4.3.3: Interrupt clear-enable registers (NVIC_ICERx) on page 196</a>
0xE00E200-0xE00E20B	NVIC_ISPR0-NVIC_ISPR2	RW	Privileged	0x00000000	<a href="#">Table 4.3.4: Interrupt set-pending registers (NVIC_ISPRx) on page 197</a>
0xE00E280-0xE00E29C	NVIC_ICPR0-NVIC_ICPR2	RW	Privileged	0x00000000	<a href="#">Table 4.3.5: Interrupt clear-pending registers (NVIC_ICPRx) on page 198</a>
0xE00E300-0xE00E31C	NVIC_IABR0-NVIC_IABR2	RW	Privileged	0x00000000	<a href="#">Table 4.3.6: Interrupt active bit registers (NVIC_IABRx) on page 199</a>
0xE00E400-0xE00E503	NVIC_IPR0-NVIC_IPR20	RW	Privileged	0x00000000	<a href="#">Table 4.3.7: Interrupt priority registers (NVIC_IPRx) on page 200</a>
0xE00EF00	STIR	WO	Configurable	0x00000000	<a href="#">Table 4.3.8: Software trigger interrupt register (NVIC_STIR) on page 201</a>

### 4.3.1 Accessing the Cortex-M4 NVIC registers using CMSIS

CMSIS functions enable software portability between different Cortex-M profile processors. To access the NVIC registers when using CMSIS, use the following functions:

**Table 46. CMSIS access NVIC functions**

CMSIS function <sup>(1)</sup>	Description
void NVIC_EnableIRQ(IRQn_Type IRQn)	Enables an interrupt or exception.
void NVIC_DisableIRQ(IRQn_Type IRQn)	Disables an interrupt or exception.
void NVIC_SetPendingIRQ(IRQn_Type IRQn)	Sets the pending status of interrupt or exception to 1.
void NVIC_ClearPendingIRQ(IRQn_Type IRQn)	Clears the pending status of interrupt or exception to 0.
uint32_t NVIC_GetPendingIRQ(IRQn_Type IRQn)	Reads the pending status of interrupt or exception. This function returns non-zero value if the pending status is set to 1.
void NVIC_SetPriority(IRQn_Type IRQn, uint32_t priority)	Sets the priority of an interrupt or exception with configurable priority level to 1.
uint32_t NVIC_GetPriority(IRQn_Type IRQn)	Reads the priority of an interrupt or exception with configurable priority level. This function return the current priority level.

1. The input parameter IRQn is the IRQ number,

### 4.3.2 Interrupt set-enable registers (NVIC\_ISERx)

Address offset: 0x00 - 0x0B

Reset value: 0x0000 0000

Required privilege: Privileged

31	30	29	28	27	26	25	24	23	22	21	20	19	18	17	16
SETENA[31:16]															
rs	rs	rs	rs	rs	rs	rs	rs	rs	rs	rs	rs	rs	rs	rs	rs
15	14	13	12	11	10	9	8	7	6	5	4	3	2	1	0
SETENA[15:0]															
rs	rs	rs	rs	rs	rs	rs	rs	rs	rs	rs	rs	rs	rs	rs	rs

Bits 31:0 **SETENA**: Interrupt set-enable bits.

**Write:**

- 0: No effect
- 1: Enable interrupt

**Read:**

- 0: Interrupt disabled
- 1: Interrupt enabled.

If a pending interrupt is enabled, the NVIC activates the interrupt based on its priority. If an interrupt is not enabled, asserting its interrupt signal changes the interrupt state to pending, but the NVIC never activates the interrupt, regardless of its priority.

### 4.3.3 Interrupt clear-enable registers (NVIC\_ICERx)

Address offset: 0x00 - 0x0B

Reset value: 0x0000 0000

Required privilege: Privileged

The ICER0-ICER2 registers disable interrupts, and show which interrupts are enabled.

31	30	29	28	27	26	25	24	23	22	21	20	19	18	17	16
CLRENA[31:16]															
rc_w1	rc_w1	rc_w1	rc_w1	rc_w1	rc_w1	rc_w1	rc_w1	rc_w1	rc_w1	rc_w1	rc_w1	rc_w1	rc_w1	rc_w1	rc_w1
15	14	13	12	11	10	9	8	7	6	5	4	3	2	1	0
CLRENA[15:0]															
rc_w1	rc_w1	rc_w1	rc_w1	rc_w1	rc_w1	rc_w1	rc_w1	rc_w1	rc_w1	rc_w1	rc_w1	rc_w1	rc_w1	rc_w1	rc_w1

Bits 31:0 **CLRENA**: Interrupt clear-enable bits.

**Write:**

- 0: No effect
- 1: Disable interrupt

**Read:**

- 0: Interrupt disabled
- 1: Interrupt enabled.

### 4.3.4 Interrupt set-pending registers (NVIC\_ISPRx)

Address offset: 0x00 - 0x0B

Reset value: 0x0000 0000

Required privilege: Privileged

The ISPR0-ISPR2 registers force interrupts into the pending state, and show which interrupts are pending.

	31	30	29	28	27	26	25	24	23	22	21	20	19	18	17	16
SETPEND[31:16]																
	rs	rs	rs	rs	rs	rs	rs	rs	rs	rs	rs	rs	rs	rs	rs	rs
	15	14	13	12	11	10	9	8	7	6	5	4	3	2	1	0
SETPEND[15:0]																
	rs	rs	rs	rs	rs	rs	rs	rs	rs	rs	rs	rs	rs	rs	rs	rs

Bits 31:0 **SETPEND**: Interrupt set-pending bits

**Write:**

- 0: No effect
- 1: Changes interrupt state to pending

**Read:**

- 0: Interrupt is not pending
- 1: Interrupt is pending

Writing 1 to the ISPR bit corresponding to an interrupt that is pending:

- has no effect.

Writing 1 to the ISPR bit corresponding to a disabled interrupt:

- sets the state of that interrupt to pending.

### 4.3.5 Interrupt clear-pending registers (NVIC\_ICPRx)

Address offset: 0x00 - 0x0B

Reset value: 0x0000 0000

Required privilege: Privileged

The ICPR0-ICPR2 registers remove the pending state from interrupts, and show which interrupts are pending.

31	30	29	28	27	26	25	24	23	22	21	20	19	18	17	16
CLRPEND[31:16]															
rc_w1	rc_w1	rc_w1	rc_w1	rc_w1	rc_w1	rc_w1	rc_w1	rc_w1	rc_w1	rc_w1	rc_w1	rc_w1	rc_w1	rc_w1	rc_w1
15	14	13	12	11	10	9	8	7	6	5	4	3	2	1	0
CLRPEND[15:0]															
rc_w1	rc_w1	rc_w1	rc_w1	rc_w1	rc_w1	rc_w1	rc_w1	rc_w1	rc_w1	rc_w1	rc_w1	rc_w1	rc_w1	rc_w1	rc_w1

Bits 31:0 **CLRPEND**: Interrupt clear-pending bits

**Write:**

- 0: No effect
- 1: Removes the pending state of an interrupt

**Read:**

- 0: Interrupt is not pending
- 1: Interrupt is pending

Writing 1 to an ICPR bit does not affect the active state of the corresponding interrupt.

### 4.3.6 Interrupt active bit registers (NVIC\_IABRx)

Address offset: 0x00- 0x0B

Reset value: 0x0000 0000

Required privilege: Privileged

The IABR0-IABR2 registers indicate which interrupts are active.

The bit assignments are:

31	30	29	28	27	26	25	24	23	22	21	20	19	18	17	16
ACTIVE[31:16]															
r	r	r	r	r	r	r	r	r	r	r	r	r	r	r	r
15	14	13	12	11	10	9	8	7	6	5	4	3	2	1	0
ACTIVE[15:0]															
r	r	r	r	r	r	r	r	r	r	r	r	r	r	r	r

Bits 31:0 **ACTIVE**: Interrupt active flags

0: Interrupt not active

1: Interrupt active

A bit reads as 1 if the status of the corresponding interrupt is active or active and pending.

### 4.3.7 Interrupt priority registers (NVIC\_IPRx)

Address offset: 0x00- 0x0B

Reset value: 0x0000 0000

Required privilege: Privileged

The NVIC\_IPR0-IPR80 registers provide an 8-bit priority field for each interrupt. These registers are byte-accessible. Each register holds four priority fields, that map to four elements in the CMSIS interrupt priority array IP[0] to IP[67], as shown in [Figure 19](#).

**Figure 19. NVIC\_IPRx register mapping**

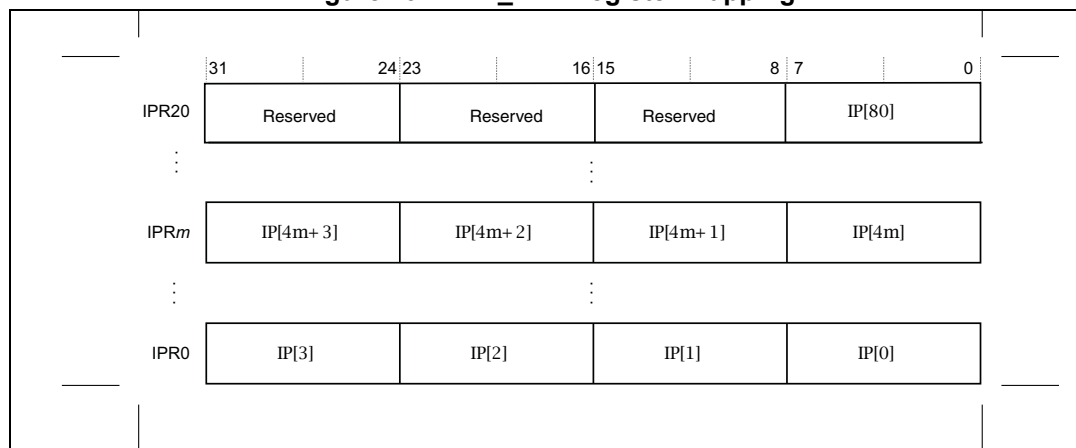

**Table 47. IPR bit assignments**

Bits	Name	Function
[31:24]	Priority, byte offset 3	Each priority field holds a priority value, 0-255. The lower the value, the greater the priority of the corresponding interrupt. The processor implements only bits[7:4] of each field, bits[3:0] read as zero and ignore writes.
[23:16]	Priority, byte offset 2	
[15:8]	Priority, byte offset 1	
[7:0]	Priority, byte offset 0	

See [Interrupt set-enable registers \(NVIC\\_ISERx\) on page 195](#) for more information about the interrupt priority array, that provides the software view of the interrupt priorities.

Find the IPR number and byte offset for interrupt *N* as follows:

- The corresponding IPR number, *M*, is given by  $M = N \text{ DIV } 4$
- The byte offset of the required Priority field in this register is  $N \text{ MOD } 4$ , where:
  - byte offset 0 refers to register bits[7:0]
  - byte offset 1 refers to register bits[15:8]
  - byte offset 2 refers to register bits[23:16]
  - byte offset 3 refers to register bits[31:24].



### 4.3.8 Software trigger interrupt register (NVIC\_STIR)

Address offset: 0xE00

Reset value: 0x0000 0000

Required privilege: When the USERSETMPEND bit in the SCR is set to 1, unprivileged software can access the STIR, see [Section 4.4.6: System control register \(SCR\)](#). Only privileged software can enable unprivileged access to the STIR.

31	30	29	28	27	26	25	24	23	22	21	20	19	18	17	16	
Reserved																
15	14	13	12	11	10	9	8	7	6	5	4	3	2	1	0	
Reserved							INTID[8:0]									
							w	w	w	w	w	w	w	w	w	w

Bits 31:9 Reserved, must be kept cleared.

Bits 8:0 **INTID** Software generated interrupt ID

Write to the STIR to generate a Software Generated Interrupt (SGI). The value to be written is the Interrupt ID of the required SGI, in the range 0-239. For example, a value of 0x03 specifies interrupt IRQ3.

### 4.3.9 Level-sensitive and pulse interrupts

STM32 interrupts are both level-sensitive and pulse-sensitive. Pulse interrupts are also described as edge-triggered interrupts.

A level-sensitive interrupt is held asserted until the peripheral deasserts the interrupt signal. Typically this happens because the ISR accesses the peripheral, causing it to clear the interrupt request. A pulse interrupt is an interrupt signal sampled synchronously on the rising edge of the processor clock. To ensure the NVIC detects the interrupt, the peripheral must assert the interrupt signal for at least one clock cycle, during which the NVIC detects the pulse and latches the interrupt.

When the processor enters the ISR, it automatically removes the pending state from the interrupt, see [Hardware and software control of interrupts](#). For a level-sensitive interrupt, if the signal is not deasserted before the processor returns from the ISR, the interrupt becomes pending again, and the processor must execute its ISR again. This means that the peripheral can hold the interrupt signal asserted until it no longer needs servicing.

#### Hardware and software control of interrupts

The Cortex-M4 latches all interrupts. A peripheral interrupt becomes pending for one of the following reasons:

- The NVIC detects that the interrupt signal is HIGH and the interrupt is not active
- The NVIC detects a rising edge on the interrupt signal
- Software writes to the corresponding interrupt set-pending register bit, see [Section 4.3.4: Interrupt set-pending registers \(NVIC\\_ISPRx\)](#), or to the STIR to make an SGI pending, see [Section 4.3.8: Software trigger interrupt register \(NVIC\\_STIR\)](#).

A pending interrupt remains pending until one of the following:

- The processor enters the ISR for the interrupt. This changes the state of the interrupt from pending to active. Then:
  - For a level-sensitive interrupt, when the processor returns from the ISR, the NVIC samples the interrupt signal. If the signal is asserted, the state of the interrupt changes to pending, which might cause the processor to immediately re-enter the ISR. Otherwise, the state of the interrupt changes to inactive.
  - For a pulse interrupt, the NVIC continues to monitor the interrupt signal, and if this is pulsed the state of the interrupt changes to pending and active. In this case, when the processor returns from the ISR the state of the interrupt changes to pending, which might cause the processor to immediately re-enter the ISR. If the interrupt signal is not pulsed while the processor is in the ISR, when the processor returns from the ISR the state of the interrupt changes to inactive.
- Software writes to the corresponding interrupt clear-pending register bit.

For a level-sensitive interrupt, if the interrupt signal is still asserted, the state of the interrupt does not change. Otherwise, the state of the interrupt changes to inactive.

For a pulse interrupt, state of the interrupt changes to:

  - Inactive, if the state was pending
  - Active, if the state was active and pending.

### 4.3.10 NVIC design hints and tips

Ensure software uses correctly aligned register accesses. The processor does not support unaligned accesses to NVIC registers. See the individual register descriptions for the supported access sizes.

An interrupt can enter pending state even it is disabled. Disabling an interrupt only prevents the processor from taking that interrupt.

Before programming VTOR to relocate the vector table, ensure the vector table entries of the new vector table are setup for fault handlers, NMI and all enabled exception like interrupts. For more information see [Section 4.4.4: Vector table offset register \(VTOR\) on page 212](#).

#### NVIC programming hints

Software uses the CPSIE I and CPSID I instructions to enable and disable interrupts. The CMSIS provides the following intrinsic functions for these instructions:

```
void __disable_irq(void) // Disable Interrupts
void __enable_irq(void) // Enable Interrupts
```

In addition, the CMSIS provides a number of functions for NVIC control, including:

**Table 48. CMSIS functions for NVIC control**

CMSIS interrupt control function	Description
void NVIC_SetPriorityGrouping(uint32_t priority_grouping)	Set the priority grouping
void NVIC_EnableIRQ(IRQn_t IRQn)	Enable IRQn
void NVIC_DisableIRQ(IRQn_t IRQn)	Disable IRQn
uint32_t NVIC_GetPendingIRQ (IRQn_t IRQn)	Return true (IRQ-Number) if IRQn is pending
void NVIC_SetPendingIRQ (IRQn_t IRQn)	Set IRQn pending
void NVIC_ClearPendingIRQ (IRQn_t IRQn)	Clear IRQn pending status
uint32_t NVIC_GetActive (IRQn_t IRQn)	Return the IRQ number of the active interrupt
void NVIC_SetPriority (IRQn_t IRQn, uint32_t priority)	Set priority for IRQn
uint32_t NVIC_GetPriority (IRQn_t IRQn)	Read priority of IRQn
void NVIC_SystemReset (void)	Reset the system

The input parameter IRQn is the IRQ number, see [Table 17: Properties of the different exception types on page 37](#). For more information about these functions see the CMSIS documentation.

### 4.3.11 NVIC register map

This table shows the NVIC register map and reset values. The base address of the main NVIC register block is 0xE000E100. The NVIC\_STIR register is located in a separate block at 0xE000EF00.

**Table 49. NVIC register map and reset values**

Offset	Register	31	30	29	28	27	26	25	24	23	22	21	20	19	18	17	16	15	14	13	12	11	10	9	8	7	6	5	4	3	2	1	0	
0x000	NVIC_ISER0	SETENA[31:0]																																
	Reset Value	0	0	0	0	0	0	0	0	0	0	0	0	0	0	0	0	0	0	0	0	0	0	0	0	0	0	0	0	0	0	0	0	0
0x004	NVIC_ISER1	SETENA[63:32]																																
	Reset Value	0	0	0	0	0	0	0	0	0	0	0	0	0	0	0	0	0	0	0	0	0	0	0	0	0	0	0	0	0	0	0	0	0
0x008	NVIC_ISER2	Reserved																SETENA [80:64]																
	Reset Value																0	0	0	0	0	0	0	0	0	0	0	0	0	0	0	0	0	
0x080	NVIC_ICER0	CLRENA[31:0]																																
	Reset Value	0	0	0	0	0	0	0	0	0	0	0	0	0	0	0	0	0	0	0	0	0	0	0	0	0	0	0	0	0	0	0	0	0
0x084	NVIC_ICER1	CLRENA[63:32]																																
	Reset Value	0	0	0	0	0	0	0	0	0	0	0	0	0	0	0	0	0	0	0	0	0	0	0	0	0	0	0	0	0	0	0	0	0
0x088	NVIC_ICER2	Reserved																CLRENA [80:64]																
	Reset Value																0	0	0	0	0	0	0	0	0	0	0	0	0	0	0	0	0	0
0x100	NVIC_ISPR0	SETPEND[31:0]																																
	Reset Value	0	0	0	0	0	0	0	0	0	0	0	0	0	0	0	0	0	0	0	0	0	0	0	0	0	0	0	0	0	0	0	0	0
0x104	NVIC_ISPR1	SETPEND[63:32]																																
	Reset Value	0	0	0	0	0	0	0	0	0	0	0	0	0	0	0	0	0	0	0	0	0	0	0	0	0	0	0	0	0	0	0	0	0
0x108	NVIC_ISPR2	Reserved																SETPEND [80:64]																
	Reset Value																0	0	0	0	0	0	0	0	0	0	0	0	0	0	0	0	0	0
0x180	NVIC_ICPR0	CLRPEND[31:0]																																
	Reset Value	0	0	0	0	0	0	0	0	0	0	0	0	0	0	0	0	0	0	0	0	0	0	0	0	0	0	0	0	0	0	0	0	0
0x184	NVIC_ICPR1	CLRPEND[63:32]																																
	Reset Value	0	0	0	0	0	0	0	0	0	0	0	0	0	0	0	0	0	0	0	0	0	0	0	0	0	0	0	0	0	0	0	0	0
0x188	NVIC_ICPR2	Reserved																CLRPEND [80:64]																
	Reset Value																0	0	0	0	0	0	0	0	0	0	0	0	0	0	0	0	0	0
0x200	NVIC_IABR0	ACTIVE[31:0]																																
	Reset Value	0	0	0	0	0	0	0	0	0	0	0	0	0	0	0	0	0	0	0	0	0	0	0	0	0	0	0	0	0	0	0	0	0
0x204	NVIC_IABR1	ACTIVE[63:32]																																
	Reset Value	0	0	0	0	0	0	0	0	0	0	0	0	0	0	0	0	0	0	0	0	0	0	0	0	0	0	0	0	0	0	0	0	0
0x208	NVIC_IABR2	Reserved																ACTIVE [80:64]																
	Reset Value																0	0	0	0	0	0	0	0	0	0	0	0	0	0	0	0	0	0

Table 49. NVIC register map and reset values (continued)

Offset	Register	31	30	29	28	27	26	25	24	23	22	21	20	19	18	17	16	15	14	13	12	11	10	9	8	7	6	5	4	3	2	1	0																					
0x300	NVIC_IPR0	IP[3]								IP[2]								IP[1]								IP[0]																												
	Reset Value	0	0	0	0	0	0	0	0	0	0	0	0	0	0	0	0	0	0	0	0	0	0	0	0	0	0	0	0	0	0	0	0	0																				
:	:	:																																																				
0x320	NVIC_IPR20	Reserved																								IP[80]																												
	Reset Value	0	0	0	0	0	0	0	0	0	0	0	0	0	0	0	0	0	0	0	0	0	0	0	0	0	0	0	0	0	0	0	0	0																				
SCB registers																																																						
Reserved																																																						
0xE00	NVIC_STIR	Reserved																								INTID[8:0]																												
	Reset Value																									0	0	0	0	0	0	0	0	0	0	0	0	0	0	0	0	0	0	0	0	0	0	0	0	0	0	0	0	0

## 4.4 System control block (SCB)

The *System control block* (SCB) provides system implementation information, and system control. This includes configuration, control, and reporting of the system exceptions.

**Table 50. Summary of the system control block registers**

Address	Name	Type	Required privilege	Reset value	Description
0xE000E008	ACTLR	RW	Privileged	0x00000000	<a href="#">Table 4.4.1: Auxiliary control register (ACTLR) on page 207</a>
0xE000ED00	CPUID	RO	Privileged	0x410FC241	<a href="#">Table 4.4.2: CPUID base register (CPUID) on page 208</a>
0xE000ED04	ICSR	RW <sup>(1)</sup>	Privileged	0x00000000	<a href="#">Table 4.4.3: Interrupt control and state register (ICSR) on page 210</a>
0xE000ED08	VTOR	RW	Privileged	0x00000000	<a href="#">Table 4.4.4: Vector table offset register (VTOR) on page 212</a>
0xE000ED0C	AIRCR	RW <sup>(1)</sup>	Privileged	0xFA050000	<a href="#">Table 4.4.5: Application interrupt and reset control register (AIRCR) on page 212</a>
0xE000ED10	SCR	RW	Privileged	0x00000000	<a href="#">Table 4.4.6: System control register (SCR) on page 214</a>
0xE000ED14	CCR	RW	Privileged	0x00000200	<a href="#">Table 4.4.7: Configuration and control register (CCR) on page 215</a>
0xE000ED18	SHPR1	RW	Privileged	0x00000000	<a href="#">Table 4.4.8: System handler priority registers (SHPRx) on page 217</a>
0xE000ED1C	SHPR2	RW	Privileged	0x00000000	
0xE000ED20	SHPR3	RW	Privileged	0x00000000	
0xE000ED24	SHCRS	RW	Privileged	0x00000000	<a href="#">Table 4.4.9: System handler control and state register (SHCSR) on page 219</a>
0xE000ED28	CFSR	RW	Privileged	0x00000000	<a href="#">Table 4.4.10: Configurable fault status register (CFSR; UFSR+BFSSR+MMFSR) on page 221</a>
0xE000ED28	MMSR <sup>(2)</sup>	RW	Privileged	0x00	MemManage Fault Status Register <a href="#">Table 4.4.10 on page 221</a>
0xE000ED29	BFSSR <sup>(2)</sup>	RW	Privileged	0x00	BusFault Status Register <a href="#">Table 4.4.10 on page 221</a>
0xE000ED2A	UFSR <sup>(2)</sup>	RW	Privileged	0x0000	UsageFault Status Register <a href="#">Table 4.4.10 on page 221</a>
0xE000ED2C	HFSR	RW	Privileged	0x00000000	<a href="#">Table 4.4.14: Hard fault status register (HFSR) on page 225</a>
0xE000ED34	MMAR	RW	Privileged	Unknown	<a href="#">Table 4.4.15: Memory management fault address register (MMFAR) on page 226</a>
0xE000ED38	BFAR	RW	Privileged	Unknown	<a href="#">Table 4.4.16: Bus fault address register (BFAR) on page 226</a>
0xE000ED3C	AFSR	RW	Privileged	0x00000000	<a href="#">Table 4.4.17: Auxiliary fault status register (AFSR) on page 227</a>

1. See the register description for more information.
2. A subregister of the CFSR

### 4.4.1 Auxiliary control register (ACTLR)

Address offset: 0x00 (base address = 0xE000 E008)

Reset value: 0x0000 0000

Required privilege: Privileged

By default this register is set to provide optimum performance from the Cortex-M4 processor, and does not normally require modification. The ACTLR register provides disable bits for the following processor functions:

- IT folding
- write buffer use for accesses to the default memory map
- interruption of multi-cycle instructions.

31	30	29	28	27	26	25	24	23	22	21	20	19	18	17	16
Reserved															
15	14	13	12	11	10	9	8	7	6	5	4	3	2	1	0
Reserved						DISO FP	DISFP CA						DISFOL D	DISDE FWBUF	DISMC YCINT
						rw	rw						rw	rw	rw

Bits 31:10 Reserved

Bit 9 DISOFP

Disables floating point instructions completing out of order with respect to integer instructions.

Bit 8 DISFPCA

Disables automatic update of CONTROL.FPCA.

The value of this bit should be written as zero or preserved (SBZP).

Bit 7:3 Reserved

Bit 2 DISFOLD

Disables folding of IT instructions:

- 0: Enables IT instructions folding.
- 1: Disables IT instructions folding.

In some situations, the processor can start executing the first instruction in an IT block while it is still executing the IT instruction. This behavior is called IT folding, and improves performance. However, IT folding can cause jitter in looping. If a task must avoid jitter, set the DISFOLD bit to 1 before executing the task, to disable IT folding.

Bit 1 DISDEFWBUF

This bit only affects write buffers implemented in the Cortex-M4 processor.

Disables write buffer use during default memory map accesses: This causes all BusFaults to be precise BusFaults but decreases performance because any store to memory must complete before the processor can execute the next instruction.

- 0: Enable write buffer use: stores to memory is completed before next instruction.
- 1: Disable write buffer use.

Bit 0 DISMCYCINT

Disables interrupt of multi-cycle instructions. When set to 1, disables interruption of load multiple and store multiple instructions. This increases the interrupt latency of the processor because any LDM or STM must complete before the processor can stack the current state and enter the interrupt handler.

- 0: Enable interruption latency of the processor (load/store and multiply/divide operations).
- 1: Disable interruptions latency.

### 4.4.2 CPUID base register (CPUID)

Address offset: 0x00

Reset value: 0x410F C241

Required privilege: Privileged

The CPUID register contains the processor part number, version, and implementation information.

31	30	29	28	27	26	25	24	23	22	21	20	19	18	17	16
Implementer								Variant				Constant			
r	r	r	r	r	r	r	r	r	r	r	r	r	r	r	r
15	14	13	12	11	10	9	8	7	6	5	4	3	2	1	0
PartNo												Revision			
r	r	r	r	r	r	r	r	r	r	r	r	r	r	r	r

Bits 31:24 **Implementer:** Implementer code  
0x41: ARM

Bits 23:20 **Variant:** Variant number  
The r value in the *rnpn* product revision identifier  
0x0: revision 0



Bits 19:16 **Constant:** Reads as 0xF

Bits 15:4 **PartNo:** Part number of the processor  
0xC24: = Cortex-M4

Bits 3:0 **Revision:** Revision number

The p value in the *rrpn* product revision identifier, indicates patch release.  
0x1: = patch 1

### 4.4.3 Interrupt control and state register (ICSR)

Address offset: 0x04

Reset value: 0x0000 0000

Required privilege: Privileged

The ICSR:

- Provides:
  - A set-pending bit for the *Non-Maskable Interrupt* (NMI) exception
  - Set-pending and clear-pending bits for the PendSV and SysTick exceptions
- Indicates:
  - The exception number of the exception being processed
  - Whether there are preempted active exceptions
  - The exception number of the highest priority pending exception
  - Whether any interrupts are pending.

**Caution:** When you write to the ICSR, the effect is unpredictable if you:

- Write 1 to the PENDSVSET bit and write 1 to the PENDSVCLR bit
- Write 1 to the PENDSTSET bit and write 1 to the PENDSTCLR bit.

	31	30	29	28	27	26	25	24	23	22	21	20	19	18	17	16	
NMIPENDSET	Reserved			PENDSVSET	PENDSVCLR	PENDSTSET	PENDSTCLR	Reserved			ISRSPENDING	Reserved			VECTPENDING[6:4]		
rw				rw	w	rw	w				r				r	r	r
	15	14	13	12	11	10	9	8	7	6	5	4	3	2	1	0	
VECTPENDING[3:0]				RETOBASE	Reserved			VECTACTIVE[8:0]									
r	r	r	r	r				rw	rw	rw	rw	rw	rw	rw	rw	rw	

Bit 31 **NMIPENDSET**: NMI set-pending bit.

Write:

- 0: No effect
- 1: Change NMI exception state to pending.

Read:

- 0: NMI exception is not pending
- 1: NMI exception is pending

Because NMI is the highest-priority exception, normally the processor enter the NMI exception handler as soon as it registers a write of 1 to this bit, and entering the handler clears this bit to 0. A read of this bit by the NMI exception handler returns 1 only if the NMI signal is reasserted while the processor is executing that handler.

Bits 30:29 Reserved

- Bit 28 **PENDSVSET**: PendSV set-pending bit.  
 Write:  
 0: No effect  
 1: Change PendSV exception state to pending.  
 Read:  
 0: PendSV exception is not pending  
 1: PendSV exception is pending  
 Writing 1 to this bit is the only way to set the PendSV exception state to pending.
- Bit 27 **PENDSVCLR**: PendSV clear-pending bit. This bit is write-only. On a read, value is unknown.  
 0: No effect  
 1: Removes the pending state from the PendSV exception.
- Bit 26 **PENDSTSET**: SysTick exception set-pending bit.  
**Write:**  
 0: No effect  
 1: Change SysTick exception state to pending  
**Read:**  
 0: SysTick exception is not pending  
 1: SysTick exception is pending
- Bit 25 **PENDSTCLR**: SysTick exception clear-pending bit. Write-only. On a read, value is unknown.  
 0: No effect  
 1: Removes the pending state from the SysTick exception.
- Bit 24 Reserved, must be kept cleared.
- Bit 23 This bit is reserved for Debug use and reads-as-zero when the processor is not in Debug.
- Bit 22 **ISR\_PENDING**: Interrupt pending flag, excluding NMI and Faults.  
 0: Interrupt not pending  
 1: Interrupt pending
- Bits 21:19 Reserved, must be kept cleared.
- Bits 18:12 **VECTPENDING**: Pending vector. Indicates the exception number of the highest priority pending enabled exception.  
 0: No pending exceptions  
 Other values: The exception number of the highest priority pending enabled exception.  
 The value indicated by this field includes the effect of the BASEPRI and FAULTMASK registers, but not any effect of the PRIMASK register.
- Bit 11 **RETTOBASE**: Return to base level. Indicates whether there are preempted active exceptions:  
 0: There are preempted active exceptions to execute  
 1: There are no active exceptions, or the currently-executing exception is the only active exception.
- Bits 10:9 Reserved
- Bits 8:0 **VECTACTIVE** Active vector. Contains the active exception number:  
 0: Thread mode  
 Other values: The exception number<sup>(1)</sup> of the currently active exception.  
*Note: Subtract 16 from this value to obtain CMSIS IRQ number required to index into the Interrupt Clear-Enable, Set-Enable, Clear-Pending, Set-Pending, or Priority Registers, see Table 6 on page 21.*

1. This is the same value as IPSR bits[8:0], see [Interrupt program status register on page 21](#).

### 4.4.4 Vector table offset register (VTOR)

Address offset: 0x08

Reset value: 0x0000 0000

Required privilege: Privileged

31	30	29	28	27	26	25	24	23	22	21	20	19	18	17	16
Reserved		TBLOFF[29:16]													
		rw	rw	rw	rw	rw	rw	rw	rw	rw	rw	rw	rw	rw	rw
15	14	13	12	11	10	9	8	7	6	5	4	3	2	1	0
TBLOFF[15:9]							Reserved								
rw	rw	rw	rw	rw	rw	rw									

Bits 31:30 Reserved, must be kept cleared

Bits 29:9 **TBLOFF**: Vector table base offset field.

It contains bits [29:9] of the offset of the table base from memory address 0x00000000. When setting TBLOFF, you must align the offset to the number of exception entries in the vector table. The minimum alignment is 128 words. Table alignment requirements mean that bits[8:0] of the table offset are always zero.

Bit 29 determines whether the vector table is in the code or SRAM memory region.

0: Code

1: SRAM

*Note: Bit 29 is sometimes called the TBLBASE bit.*

Bits 8:0 Reserved, must be kept cleared

### 4.4.5 Application interrupt and reset control register (AIRCR)

Address offset: 0x0C

Reset value: 0xFA05 0000

Required privilege: Privileged

The AIRCR provides priority grouping control for the exception model, endian status for data accesses, and reset control of the system.

To write to this register, you must write 0x5FA to the VECTKEY field, otherwise the processor ignores the write.

31	30	29	28	27	26	25	24	23	22	21	20	19	18	17	16
VECTKEYSTAT[15:0](read)/ VECTKEY[15:0](write)															
rw	rw	rw	rw	rw	rw	rw	rw	rw	rw	rw	rw	rw	rw	rw	rw
15	14	13	12	11	10	9	8	7	6	5	4	3	2	1	0
ENDIANNESS	Reserved				PRIGROUP			Reserved					SYS RESET REQ	VECT CLR ACTIVE	VECT RESET
	r					rw	rw	rw						w	w



- Bits 31:16 **VECTKEYSTAT/ VECTKEY** Register key  
 Reads as 0xFA05  
 On writes, write 0x5FA to VECTKEY, otherwise the write is ignored.
- Bit 15 **ENDIANESS** Data endianness bit  
 Reads as 0.  
 0: Little-endian
- Bits 14:11 Reserved, must be kept cleared
- Bits 10:8 **PRIGROUP**: Interrupt priority grouping field  
 This field determines the split of group priority from subpriority, see [Binary point on page 213](#).
- Bits 7:3 Reserved, must be kept cleared
- Bit 2 **SYSRESETREQ** System reset request  
 This is intended to force a large system reset of all major components except for debug.  
 This bit reads as 0.  
 0: No system reset request  
 1: Asserts a signal to the outer system that requests a reset.
- Bit 1 **VECTCLRACTIVE**  
 Reserved for Debug use. This bit reads as 0. When writing to the register you must write 0 to this bit, otherwise behavior is unpredictable.
- Bit 0 **VECTRESET**  
 Reserved for Debug use. This bit reads as 0. When writing to the register you must write 0 to this bit, otherwise behavior is unpredictable.

**Binary point**

The PRIGROUP field indicates the position of the binary point that splits the PRI<sub>n</sub> fields in the Interrupt Priority Registers into separate *group priority* and *subpriority* fields. [Table 51](#) shows how the PRIGROUP value controls this split. If you implement fewer than 8 priority bits you might require more explanation here, and want to remove invalid rows from the table, and modify the entries in the number of columns.

**Table 51. Priority grouping**

PRIGROUP [2:0]	Interrupt priority level value, PRI <sub>N</sub> [7:4]			Number of	
	Binary point <sup>(1)</sup>	Group priority bits	Subpriority bits	Group priorities	Sub priorities
0b011	0bxxxx	[7:4]	None	16	None
0b100	0bxxx.y	[7:5]	[4]	8	2
0b101	0bxx.yy	[7:6]	[5:4]	4	4
0b110	0bx.yyy	[7]	[6:4]	2	8
0b111	0b.yyyy	None	[7:4]	None	16

1. PRI<sub>n</sub>[7:4] field showing the binary point. x denotes a group priority field bit, and y denotes a subpriority field bit.

Determining preemption of an exception uses only the group priority field, see [Section 2.3.6: Interrupt priority grouping on page 40](#).

### 4.4.6 System control register (SCR)

Address offset: 0x10

Reset value: 0x0000 0000

Required privilege: Privileged

The SCR controls features of entry to and exit from low power state.

31	30	29	28	27	26	25	24	23	22	21	20	19	18	17	16
Reserved															
15	14	13	12	11	10	9	8	7	6	5	4	3	2	1	0
Reserved											SEVON PEND	Res.	SLEEP DEEP	SLEEP ON EXIT	Res.
											rw		rw	rw	

Bits 31:5 Reserved, must be kept cleared

Bit 4 **SEVONPEND** Send Event on Pending bit

When an event or interrupt enters pending state, the event signal wakes up the processor from WFE. If the processor is not waiting for an event, the event is registered and affects the next WFE.

The processor also wakes up on execution of an SEV instruction or an external event

0: Only enabled interrupts or events can wakeup the processor, disabled interrupts are excluded

1: Enabled events and all interrupts, including disabled interrupts, can wakeup the processor.

Bit 3 Reserved, must be kept cleared

Bit 2 **SLEEPDEEP**

Controls whether the processor uses sleep or deep sleep as its low power mode:

0: Sleep

1: Deep sleep.

Bit 1 **SLEEPONEXIT**

Configures sleep-on-exit when returning from Handler mode to Thread mode. Setting this bit to 1 enables an interrupt-driven application to avoid returning to an empty main application.

0: Do not sleep when returning to Thread mode.

1: Enter sleep, or deep sleep, on return from an interrupt service routine.

Bit 0 Reserved, must be kept cleared

### 4.4.7 Configuration and control register (CCR)

Address offset: 0x14

Reset value: 0x0000 0200

Required privilege: Privileged

The CCR controls entry to Thread mode and enables:

- The handlers for NMI, hard fault and faults escalated by FAULTMASK to ignore bus faults
- Trapping of divide by zero and unaligned accesses
- Access to the STIR by unprivileged software, see [Software trigger interrupt register \(NVIC\\_STIR\) on page 201](#).

31	30	29	28	27	26	25	24	23	22	21	20	19	18	17	16	
Reserved																
15	14	13	12	11	10	9	8	7	6	5	4	3	2	1	0	
Reserved						STK ALIGN	BFHF NMIGN	Reserved				DIV_0_ TRP	UN ALIGN_ TRP	Res.	USER SET MPEND	NON BASE THRD ENA
						rw	rw					rw	rw		rw	rw

Bits 31:10 Reserved, must be kept cleared

**Bit 9 STKALIGN**

Configures stack alignment on exception entry. On exception entry, the processor uses bit 9 of the stacked PSR to indicate the stack alignment. On return from the exception it uses this stacked bit to restore the correct stack alignment.

- 0: 4-byte aligned
- 1: 8-byte aligned

**Bit 8 BFHFNMIGN**

Enables handlers with priority -1 or -2 to ignore data bus faults caused by load and store instructions. This applies to the hard fault, NMI, and FAULTMASK escalated handlers. Set this bit to 1 only when the handler and its data are in absolutely safe memory. The normal use of this bit is to probe system devices and bridges to detect control path problems and fix them.

- 0: Data bus faults caused by load and store instructions cause a lock-up
- 1: Handlers running at priority -1 and -2 ignore data bus faults caused by load and store instructions.

Bits 7:5 Reserved, must be kept cleared

**Bit 4 DIV\_0\_TRP**

Enables faulting or halting when the processor executes an SDIV or UDIV instruction with a divisor of 0:

- 0: Do not trap divide by 0
- 1: Trap divide by 0.

When this bit is set to 0, a divide by zero returns a quotient of 0.

## Bit 3 UNALIGN\_TRP

Enables unaligned access traps:

- 0: Do not trap unaligned halfword and word accesses
- 1: Trap unaligned halfword and word accesses.

If this bit is set to 1, an unaligned access generates a usage fault.

Unaligned LDM, STM, LDRD, and STRD instructions always fault irrespective of whether UNALIGN\_TRP is set to 1.

## Bit 2 Reserved, must be kept cleared

## Bit 1 USERSETMPEND

Enables unprivileged software access to the STIR, see [Software trigger interrupt register \(NVIC\\_STIR\) on page 201](#):

- 0: Disable
- 1: Enable.

## Bit 0 NONBASETHRDENA

Configures how the processor enters Thread mode.

- 0: Processor can enter Thread mode only when no exception is active.
- 1: Processor can enter Thread mode from any level under the control of an EXC\_RETURN value, see [Exception return on page 43](#).



### 4.4.8 System handler priority registers (SHPRx)

The SHPR1-SHPR3 registers set the priority level, 0 to 255 of the exception handlers that have configurable priority.

SHPR1-SHPR3 are byte accessible.

The system fault handlers and the priority field and register for each handler are:

**Table 52. System fault handler priority fields**

Handler	Field	Register description
Memory management fault	PRI_4	<i>System handler priority register 1 (SHPR1)</i>
Bus fault	PRI_5	
Usage fault	PRI_6	
SVCall	PRI_11	<i>System handler priority register 2 (SHPR2) on page 217</i>
PendSV	PRI_14	<i>System handler priority register 3 (SHPR3) on page 218</i>
SysTick	PRI_15	

Each PRI\_N field is 8 bits wide, but the processor implements only bits[7:3] of each field, and bits[3:0] read as zero and ignore writes (where M=4).

#### System handler priority register 1 (SHPR1)

Address offset: 0x18

Reset value: 0x0000 0000

Required privilege: Privileged

31	30	29	28	27	26	25	24	23	22	21	20	19	18	17	16
Reserved								PRI_6[7:4]				PRI_6[3:0]			
								rw	rw	rw	rw	r	r	r	r
15	14	13	12	11	10	9	8	7	6	5	4	3	2	1	0
PRI_5[7:4]				PRI_5[3:0]				PRI_4[7:4]				PRI_4[3:0]			
rw	rw	rw	rw	r	r	r	r	rw	rw	rw	rw	r	r	r	r

Bits 31:24 Reserved, must be kept cleared

Bits 23:16 PRI\_6: Priority of system handler 6, usage fault

Bits 15:8 PRI\_5: Priority of system handler 5, bus fault

Bits 7:0 PRI\_4: Priority of system handler 4, memory management fault

#### System handler priority register 2 (SHPR2)

Address offset: 0x1C

Reset value: 0x0000 0000

Required privilege: Privileged



31	30	29	28	27	26	25	24	23	22	21	20	19	18	17	16	
PRI_11[7:4]				PRI_11[3:0]				Reserved								
rw	rw	rw	rw	r	r	r	r									
15	14	13	12	11	10	9	8	7	6	5	4	3	2	1	0	
Reserved																

Bits 31:24 **PRI\_11**: Priority of system handler 11, SVCall

Bits 23:0 Reserved, must be kept cleared

**System handler priority register 3 (SHPR3)**

Address: 0xE000 ED20

Reset value: 0x0000 0000

Required privilege: Privileged

31	30	29	28	27	26	25	24	23	22	21	20	19	18	17	16
PRI_15[7:4]				PRI_15[3:0]				PRI_14[7:4]				PRI_14[3:0]			
rw	rw	rw	rw	r	r	r	r	rw	rw	rw	rw	r	r	r	r
15	14	13	12	11	10	9	8	7	6	5	4	3	2	1	0
Reserved															

Bits 31:24 **PRI\_15**: Priority of system handler 15, SysTick exception

Bits 23:16 **PRI\_14**: Priority of system handler 14, PendSV

Bits 15:0 Reserved, must be kept cleared

### 4.4.9 System handler control and state register (SHCSR)

Address offset: 0x24

Reset value: 0x0000 0000

Required privilege: Privileged

The SHCSR enables the system handlers, and indicates:

- The pending status of the bus fault, memory management fault, and SVC exceptions
- The active status of the system handlers.

If you disable a system handler and the corresponding fault occurs, the processor treats the fault as a hard fault.

You can write to this register to change the pending or active status of system exceptions. An OS kernel can write to the active bits to perform a context switch that changes the current exception type.

- Software that changes the value of an active bit in this register without correct adjustment to the stacked content can cause the processor to generate a fault exception. Ensure software that writes to this register retains and subsequently restores the current active status.
- After you have enabled the system handlers, if you have to change the value of a bit in this register you must use a read-modify-write procedure to ensure that you change only the required bit.

Reserved													USG FAULT ENA	BUS FAULT ENA	MEM FAULT ENA	
													rw	rw	rw	
SV CALL PEND ED	BUS FAULT PEND ED	MEM FAULT PEND ED	USG FAULT PEND ED	SYS TICK ACT	PEND SV ACT	Res.	MONIT OR ACT	SV CALL ACT	Reserved				USG FAULT ACT	Res.	BUS FAULT ACT	MEM FAULT ACT
rw	rw	rw	rw	rw	rw		rw	rw					rw		rw	rw

Bits 31:19 Reserved, must be kept cleared

Bit 18 **USGFAULTENA**: Usage fault enable bit, set to 1 to enable<sup>(1)</sup>

Bit 17 **BUSFAULTENA**: Bus fault enable bit, set to 1 to enable<sup>(1)</sup>

Bit 16 **MEMFAULTENA**: Memory management fault enable bit, set to 1 to enable<sup>(1)</sup>

Bit 15 **SVCALLPENDE**D: SVC call pending bit, reads as 1 if exception is pending<sup>(2)</sup>

Bit 14 **BUSFAULTPENDE**D: Bus fault exception pending bit, reads as 1 if exception is pending<sup>(2)</sup>

Bit 13 **MEMFAULTPENDE**D: Memory management fault exception pending bit, reads as 1 if exception is pending<sup>(2)</sup>

Bit 12 **USGFAULTPENDE**D: Usage fault exception pending bit, reads as 1 if exception is pending<sup>(2)</sup>

Bit 11 **SYSTICKACT**: SysTick exception active bit, reads as 1 if exception is active<sup>(3)</sup>

Bit 10 **PENDSVACT**: PendSV exception active bit, reads as 1 if exception is active

Bit 9 Reserved, must be kept cleared



Bit 8 **MONITORACT**: Debug monitor active bit, reads as 1 if Debug monitor is active

Bit 7 **SVCALLACT**: SVC call active bit, reads as 1 if SVC call is active

Bits 6:4 Reserved, must be kept cleared

Bit 3 **USGFAULTACT**: Usage fault exception active bit, reads as 1 if exception is active

Bit 2 Reserved, must be kept cleared

Bit 1 **BUSFAULTACT**: Bus fault exception active bit, reads as 1 if exception is active

Bit 0 **MEMFAULTACT**: Memory management fault exception active bit, reads as 1 if exception is active

1. Enable bits, set to 1 to enable the exception, or set to 0 to disable the exception.
2. Pending bits, read as 1 if the exception is pending, or as 0 if it is not pending. You can write to these bits to change the pending status of the exceptions.
3. Active bits, read as 1 if the exception is active, or as 0 if it is not active. You can write to these bits to change the active status of the exceptions, but see the Caution in this section.

### 4.4.10 Configurable fault status register (CFSR; UFSR+BFSR+MMFSR)

Address offset: 0x28

Reset value: 0x0000 0000

Required privilege: Privileged

The following subsections describe the subregisters that make up the CFSR:

- [Usage fault status register \(UFSR\) on page 222](#)
- [Bus fault status register \(BFSR\) on page 223](#)
- [Memory management fault address register \(MMFSR\) on page 224](#)

The CFSR is byte accessible. You can access the CFSR or its subregisters as follows:

- Access the complete CFSR with a word access to 0xE00ED28
- Access the MMFSR with a byte access to 0xE00ED28
- Access the MMFSR and BFSR with a halfword access to 0xE00ED28
- Access the BFSR with a byte access to 0xE00ED29
- Access the UFSR with a halfword access to 0xE00ED2A.

The CFSR indicates the cause of a memory management fault, bus fault, or usage fault.

Figure 20. CFSR subregisters

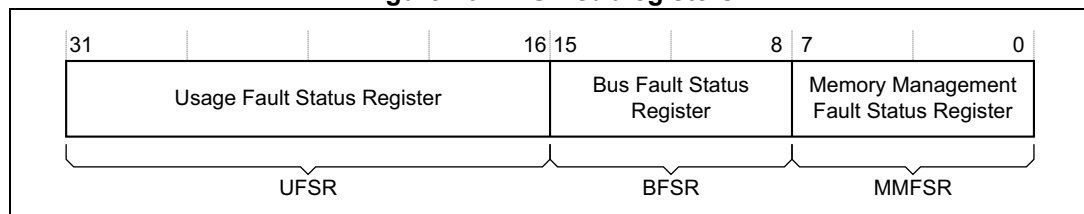

31																16		15		8						7		0					
Reserved																DIVBY ZERO		UNALIGNED		Reserved						NOCP		INVPC		INV STATE		UNDEF INSTR	
rc_w1																rc_w1		rc_w1		rc_w1						rc_w1		rc_w1		rc_w1		rc_w1	
31		30		29		28		27		26		25		24		23		22		21		20		19		18		17		16			
15		14		13		12		11		10		9		8		7		6		5		4		3		2		1		0			
BFARVALID		Reserved		LSP ERR		STK ERR		UNSTK ERR		IMPRECISE ERR		PRECISE ERR		IBUS ERR		MMAR VALID		Reserved		MLSP ERR		MSTK ERR		M UNSTK ERR		Res.		DACC VIOL		IACC VIOL			
rw				rw		rw		rw		rw		rw		rw		rw				rw		rw		rw				rw		rw			

Bits 31:16 **UFSR**: see [Usage fault status register \(UFSR\) on page 222](#)

Bits 15:8 **BFSR**: see [Bus fault status register \(BFSR\) on page 223](#)

Bits 7:0 **MMFSR**: see [Memory management fault address register \(MMFSR\) on page 224](#)

### 4.4.11 Usage fault status register (UFSR)

Bits 31:26 Reserved, must be kept cleared

- Bit 25 **DIVBYZERO**: Divide by zero usage fault. When the processor sets this bit to 1, the PC value stacked for the exception return points to the instruction that performed the divide by zero. Enable trapping of divide by zero by setting the DIV\_0\_TRP bit in the CCR to 1, see [Configuration and control register \(CCR\) on page 215](#).
- 0: No divide by zero fault, or divide by zero trapping not enabled
  - 1: The processor has executed an SDIV or UDIV instruction with a divisor of 0.

- Bit 24 **UNALIGNED**: Unaligned access usage fault. Enable trapping of unaligned accesses by setting the UNALIGN\_TRP bit in the CCR to 1, see [Configuration and control register \(CCR\) on page 215](#).

Unaligned LDM, STM, LDRD, and STRD instructions always fault irrespective of the setting of UNALIGN\_TRP.

- 0: No unaligned access fault, or unaligned access trapping not enabled
- 1: the processor has made an unaligned memory access.

Bits 23:20 Reserved, must be kept cleared

- Bit 19 **NOCP**: No coprocessor usage fault. The processor does not support coprocessor instructions:
- 0: No usage fault caused by attempting to access a coprocessor
  - 1: the processor has attempted to access a coprocessor.

- Bit 18 **INVPC**: Invalid PC load usage fault, caused by an invalid PC load by EXC\_RETURN: When this bit is set to 1, the PC value stacked for the exception return points to the instruction that tried to perform the illegal load of the PC.
- 0: No invalid PC load usage fault
  - 1: The processor has attempted an illegal load of EXC\_RETURN to the PC, as a result of an invalid context, or an invalid EXC\_RETURN value.

- Bit 17 **INVSTATE**: Invalid state usage fault. When this bit is set to 1, the PC value stacked for the exception return points to the instruction that attempted the illegal use of the EPSR. This bit is not set to 1 if an undefined instruction uses the EPSR.
- 0: No invalid state usage fault
  - 1: The processor has attempted to execute an instruction that makes illegal use of the EPSR.

- Bit 16 **UNDEFINSTR**: Undefined instruction usage fault. When this bit is set to 1, the PC value stacked for the exception return points to the undefined instruction. An undefined instruction is an instruction that the processor cannot decode.
- 0: No undefined instruction usage fault
  - 1: The processor has attempted to execute an undefined instruction.

## 4.4.12 Bus fault status register (BFSR)

- Bit 15 **BFARVALID**: *Bus Fault Address Register* (BFAR) valid flag. The processor sets this bit to 1 after a bus fault where the address is known. Other faults can set this bit to 0, such as a memory management fault occurring later.
- If a bus fault occurs and is escalated to a hard fault because of priority, the hard fault handler must set this bit to 0. This prevents problems if returning to a stacked active bus fault handler whose BFAR value has been overwritten.
- 0: Value in BFAR is not a valid fault address
  - 1: BFAR holds a valid fault address.
- Bit 14 Reserved, must be kept cleared
- Bit 13 **LSPERR**: Bus fault on floating-point lazy state preservation.
- 0: No bus fault occurred during floating-point lazy state preservation.
  - 1: A bus fault occurred during floating-point lazy state preservation
- Bit 12 **STKERR**: Bus fault on stacking for exception entry. When the processor sets this bit to 1, the SP is still adjusted but the values in the context area on the stack might be incorrect. The processor does not write a fault address to the BFAR.
- 0: No stacking fault
  - 1: Stacking for an exception entry has caused one or more bus faults.
- Bit 11 **UNSTKERR**: Bus fault on unstacking for a return from exception. This fault is chained to the handler. This means that when the processor sets this bit to 1, the original return stack is still present. The processor does not adjust the SP from the failing return, does not performed a new save, and does not write a fault address to the BFAR.
- 0: No unstacking fault
  - 1: Unstack for an exception return has caused one or more bus faults.
- Bit 10 **IMPRECISERR**: Imprecise data bus error. When the processor sets this bit to 1, it does not write a fault address to the BFAR. This is an asynchronous fault. Therefore, if it is detected when the priority of the current process is higher than the bus fault priority, the bus fault becomes pending and becomes active only when the processor returns from all higher priority processes. If a precise fault occurs before the processor enters the handler for the imprecise bus fault, the handler detects both IMPRECISERR set to 1 and one of the precise fault status bits set to 1.
- 0: No imprecise data bus error
  - 1: A data bus error has occurred, but the return address in the stack frame is not related to the instruction that caused the error.
- Bit 9 **PRECISERR**: Precise data bus error. When the processor sets this bit is 1, it writes the faulting address to the BFAR.
- 0: No precise data bus error
  - 1: A data bus error has occurred, and the PC value stacked for the exception return points to the instruction that caused the fault.
- Bit 8 **IBUSERR**: Instruction bus error. The processor detects the instruction bus error on prefetching an instruction, but it sets the IBUSERR flag to 1 only if it attempts to issue the faulting instruction.
- When the processor sets this bit is 1, it does not write a fault address to the BFAR.
- 0: No instruction bus error
  - 1: Instruction bus error.

### 4.4.13 Memory management fault address register (MMFSR)

- Bit 7 **MMARVALID**: Memory Management Fault Address Register (MMAR) valid flag. If a memory management fault occurs and is escalated to a hard fault because of priority, the hard fault handler must set this bit to 0. This prevents problems on return to a stacked active memory management fault handler whose MMAR value has been overwritten.
- 0: Value in MMAR is not a valid fault address
  - 1: MMAR holds a valid fault address.
- Bit 6 Reserved, must be kept cleared
- Bit 5 **MLSPERR**:
- 0: No MemManage fault occurred during floating-point lazy state preservation
  - 1: A MemManage fault occurred during floating-point lazy state preservation
- Bit 4 **MSTKERR**: Memory manager fault on stacking for exception entry. When this bit is 1, the SP is still adjusted but the values in the context area on the stack might be incorrect. The processor has not written a fault address to the MMAR.
- 0: No stacking fault
  - 1: Stacking for an exception entry has caused one or more access violations.
- Bit 3 **MUNSTKERR**: Memory manager fault on unstacking for a return from exception. This fault is chained to the handler. This means that when this bit is 1, the original return stack is still present. The processor has not adjusted the SP from the failing return, and has not performed a new save. The processor has not written a fault address to the MMAR.
- 0: No unstacking fault
  - 1: Unstack for an exception return has caused one or more access violations.
- Bit 2 Reserved, must be kept cleared
- Bit 1 **DACCVIOL**: Data access violation flag. When this bit is 1, the PC value stacked for the exception return points to the faulting instruction. The processor has loaded the MMAR with the address of the attempted access.
- 0: No data access violation fault
  - 1: The processor attempted a load or store at a location that does not permit the operation.
- Bit 1 **IACCVIOL**: Instruction access violation flag. This fault occurs on any access to an XN region, even the MPU is disabled or not present.
- When this bit is 1, the PC value stacked for the exception return points to the faulting instruction. The processor has not written a fault address to the MMAR.
- 0: No instruction access violation fault
  - 1: The processor attempted an instruction fetch from a location that does not permit execution.



### 4.4.14 Hard fault status register (HFSR)

Address offset: 0x2C

Reset value: 0x0000 0000

Required privilege: Privileged

The HFSR gives information about events that activate the hard fault handler. This register is read, write to clear. This means that bits in the register read normally, but writing 1 to any bit clears that bit to 0.

31	30	29	28	27	26	25	24	23	22	21	20	19	18	17	16
DEBU G_VT	FORC ED	Reserved													
rc_w1	rc_w1														
15	14	13	12	11	10	9	8	7	6	5	4	3	2	1	0
Reserved														VECT TBL	Res.
														rc_w1	

Bit 31 **DEBUG\_VT**: Reserved for Debug use. When writing to the register you must write 0 to this bit, otherwise behavior is unpredictable.

Bit 30 **FORCED**: Forced hard fault. Indicates a forced hard fault, generated by escalation of a fault with configurable priority that cannot be handles, either because of priority or because it is disabled.

When this bit is set to 1, the hard fault handler must read the other fault status registers to find the cause of the fault.

- 0: No forced hard fault
- 1: Forced hard fault.

Bits 29:2 **Reserved**, must be kept cleared

Bit 1 **VECTTBL**: Vector table hard fault. Indicates a bus fault on a vector table read during exception processing. This error is always handled by the hard fault handler.

When this bit is set to 1, the PC value stacked for the exception return points to the instruction that was preempted by the exception.

- 0: No bus fault on vector table read
- 1: Bus fault on vector table read.

Bit 0 **Reserved**, must be kept cleared

### 4.4.15 Memory management fault address register (MMFAR)

Address offset: 0x34

Reset value: undefined

Required privilege: Privileged

31	30	29	28	27	26	25	24	23	22	21	20	19	18	17	16
MMFAR[31:16]															
rw	rw	rw	rw	rw	rw	rw	rw	rw	rw	rw	rw	rw	rw	rw	rw
15	14	13	12	11	10	9	8	7	6	5	4	3	2	1	0
MMFAR[15:0]															
rw	rw	rw	rw	rw	rw	rw	rw	rw	rw	rw	rw	rw	rw	rw	rw

Bits 31:0 **MMFAR**: Memory management fault address

When the MMARVALID bit of the MMFSR is set to 1, this field holds the address of the location that generated the memory management fault.

When an unaligned access faults, the address is the actual address that faulted. Because a single read or write instruction can be split into multiple aligned accesses, the fault address can be any address in the range of the requested access size.

Flags in the MMFSR register indicate the cause of the fault, and whether the value in the MMFAR is valid. See [Configurable fault status register \(CFSR; UFSR+BFAR+MMFSR\) on page 221](#).

### 4.4.16 Bus fault address register (BFAR)

Address offset: 0x38

Reset value: undefined

Required privilege: Privileged

31	30	29	28	27	26	25	24	23	22	21	20	19	18	17	16
BFAR[31:16]															
rw	rw	rw	rw	rw	rw	rw	rw	rw	rw	rw	rw	rw	rw	rw	rw
15	14	13	12	11	10	9	8	7	6	5	4	3	2	1	0
BFAR[15:0]															
rw	rw	rw	rw	rw	rw	rw	rw	rw	rw	rw	rw	rw	rw	rw	rw

Bits 31:0 **BFAR**: Bus fault address

When the BFARVALID bit of the BFSR is set to 1, this field holds the address of the location that generated the bus fault.

When an unaligned access faults the address in the BFAR is the one requested by the instruction, even if it is not the address of the fault.

Flags in the BFSR register indicate the cause of the fault, and whether the value in the BFAR is valid. See [Configurable fault status register \(CFSR; UFSR+BFAR+MMFSR\) on page 221](#).

### 4.4.17 Auxiliary fault status register (AFSR)

Address offset: 0x3C

Reset value: undefined

Required privilege: Privileged

31	30	29	28	27	26	25	24	23	22	21	20	19	18	17	16
IMPDEF[31:16]															
rw	rw	rw	rw	rw	rw	rw	rw	rw	rw	rw	rw	rw	rw	rw	rw
15	14	13	12	11	10	9	8	7	6	5	4	3	2	1	0
IMPDEF[15:0]															
rw	rw	rw	rw	rw	rw	rw	rw	rw	rw	rw	rw	rw	rw	rw	rw

Bits 31:0 **IMPDEF**: Implementation defined. The AFSR contains additional system fault information. The bits map to the AUXFAULT input signals.

This register is read, write to clear. This means that bits in the register read normally, but writing 1 to any bit clears that bit to 0.

Each AFSR bit maps directly to an AUXFAULT input of the processor, and a single-cycle HIGH signal on the input sets the corresponding AFSR bit to one. It remains set to 1 until you write 1 to the bit to clear it to zero.

When an AFSR bit is latched as one, an exception does not occur. Use an interrupt if an exception is required.

### 4.4.18 System control block design hints and tips

Ensure software uses aligned accesses of the correct size to access the system control block registers:

- except for the CFSR and SHPR1-SHPR3, it must use aligned word accesses
- for the CFSR and SHPR1-SHPR3 it can use byte or aligned halfword or word accesses.

The processor does not support unaligned accesses to system control block registers.

In a fault handler, to determine the true faulting address:

1. Read and save the MMFAR or BFAR value.
2. Read the MMARVALID bit in the MMFSR, or the BFARVALID bit in the BFSR. The MMFAR or BFAR address is valid only if this bit is 1.

Software must follow this sequence because another higher priority exception might change the MMFAR or BFAR value. For example, if a higher priority handler preempts the current fault handler, the other fault might change the MMFAR or BFAR value.

### 4.4.19 SCB register map

The table provides shows the System control block register map and reset values. The base address of the SCB register block is 0xE000 ED00 for register described in [Table 53](#).

**Table 53. SCB register map and reset values**

Offset	Register	31	30	29	28	27	26	25	24	23	22	21	20	19	18	17	16	15	14	13	12	11	10	9	8	7	6	5	4	3	2	1	0			
0x00	CPUID	Implementer				Variant				Constant				PartNo								Revision														
	Reset Value	0	1	0	0	0	0	0	1	0	0	0	1	1	1	1	1	1	1	0	0	0	0	1	0	0	0	1	1	0	0	0	1			
0x04	ICSR	NMIPENDSET	Reserved		PENDSVSET	PENDSVCLR	PENDSTSET	PENDSTCLR	Reserved		ISR_PENDING	VECTPENDING[9:0]									RETOBASE	Reserved		VECTACTIVE[8:0]												
	Reset Value	0			0	0	0	0			0	0	0	0	0	0	0	0	0	0	0	0	0	0	0	0	0	0	0	0	0	0	0			
0x08	VTOR	Reserved		TABLEOFF[29:9]															Reserved																	
	Reset Value			0 0																																
0x0C	AIRCR	VECTKEY[15:0]															ENDIANESS	Reserved		PRIGROUP[2:0]		Reserved								SYSRESETREQ	VECTCLRACTIVE	VECTRESET				
	Reset Value	1	1	1	1	1	0	1	0	0	0	0	0	0	1	0	1	0			0 0 0										0	0	0			
0x10	SCR	Reserved																										SEVONPEND	Reserved		SLEEPDEEP	Reserved				
	Reset Value																											0			0					
0x14	CCR	Reserved																										STKALIGN	Reserved		DIV_0_TRP	UNALIGN_TRP	Reserved		USERSETMPEND	NONBASETHRDENA
	Reset Value																											1	0			0	0			0
0x18	SHPR1	Reserved								PRI6				PRI5				PRI4																		
	Reset Value									0	0	0	0	0	0	0	0	0	0	0	0	0	0	0	0	0	0	0	0	0						



Table 53. SCB register map and reset values (continued)

Offset	Register	31	30	29	28	27	26	25	24	23	22	21	20	19	18	17	16	15	14	13	12	11	10	9	8	7	6	5	4	3	2	1	0													
0x1C	SHPR2	PRI11								Reserved																																				
	Reset Value	0	0	0	0	0	0	0	0																																					
0x20	SHPR3	PRI15								PRI14								Reserved																												
	Reset Value	0	0	0	0	0	0	0	0	0	0	0	0	0	0	0	0	0	0	0	0	0	0	0	0	0	0	0	0	0	0	0	0													
0x24	SHCRS	Reserved															USG FAULT ENA	BUS FAULT ENA	MEM FAULT ENA	SV CALL PENDED	BUS FAULT PENDED	MEM FAULT PENDED	USG FAULT PENDED	SYS TICK ACT	PENDSV ACT	Reserved	MONITOR ACT	SV CALL ACT	Reserved	USG FAULT ACT	Reserved	BUS FAULT ACT	MEM FAULT ACT													
	Reset Value																0	0	0	0	0	0	0	0	0	0	0	0	0	0	0	0	0	0	0	0	0	0	0	0	0	0	0	0	0	0
0x28	CFSR	UFSR															BFSR								MMFSR																					
	Reset Value	0	0	0	0	0	0	0	0	0	0	0	0	0	0	0	0	0	0	0	0	0	0	0	0	0	0	0	0	0	0	0	0	0												
0x2C	HFSR	DEBUG_VT FORCED	Reserved																								VECTTBL																			
	Reset Value	0	0																									0																		
0x34	MMAR	MMAR[31:0]																																												
	Reset Value	x	x	x	x	x	x	x	x	x	x	x	x	x	x	x	x	x	x	x	x	x	x	x	x	x	x	x	x	x	x	x	x	x												
0x38	BFAR	BFAR[31:0]																																												
	Reset Value	x	x	x	x	x	x	x	x	x	x	x	x	x	x	x	x	x	x	x	x	x	x	x	x	x	x	x	x	x	x	x	x	x	x											
0x3C	AFSR	IMPDEF[31:0]																																												
	Reset Value	x	x	x	x	x	x	x	x	x	x	x	x	x	x	x	x	x	x	x	x	x	x	x	x	x	x	x	x	x	x	x	x	x	x											



## 4.5 SysTick timer (STK)

The processor has a 24-bit system timer, SysTick, that counts down from the reload value to zero, reloads (wraps to) the value in the STK\_LOAD register on the next clock edge, then counts down on subsequent clocks.

When the processor is halted for debugging the counter does not decrement.

**Table 54. System timer registers summary**

Address	Name	Type	Required privilege	Reset value	Description
0xE000E010	STK_CTRL	RW	Privileged	0x00000000	<i>SysTick control and status register (STK_CTRL) on page 231</i>
0xE000E014	STK_LOAD	RW	Privileged	Unknown	<i>SysTick reload value register (STK_LOAD) on page 232</i>
0xE000E018	STK_VAL	RW	Privileged	Unknown	<i>SysTick current value register (STK_VAL) on page 233</i>
0xE000E01C	STK_CALIB	RO	Privileged	0xC0000000	<i>SysTick calibration value register (STK_CALIB) on page 234</i>

### 4.5.1 SysTick control and status register (STK\_CTRL)

Address offset: 0x00

Reset value: 0x0000 0000

Required privilege: Privileged

The SysTick CTRL register enables the SysTick features.

31	30	29	28	27	26	25	24	23	22	21	20	19	18	17	16
Reserved															COUNT FLAG
															rw
15	14	13	12	11	10	9	8	7	6	5	4	3	2	1	0
Reserved												CLKSO URCE	TICK INT	EN ABLE	
												rw	rw	rw	

Bits 31:17 Reserved, must be kept cleared.

Bit 16 **COUNTFLAG**:

**Returns 1 if timer counted to 0 since last time this was read.**

Bits 15:3 Reserved, must be kept cleared.

Bit 2 **CLKSOURCE**: Clock source selection

Selects the clock source.

0: AHB/8

1: Processor clock (AHB)

Bit 1 **TICKINT**: SysTick exception request enable

0: Counting down to zero does not assert the SysTick exception request

1: Counting down to zero to asserts the SysTick exception request.

*Note: Software can use COUNTFLAG to determine if SysTick has ever counted to zero.*

Bit 0 **ENABLE**: Counter enable

Enables the counter. When ENABLE is set to 1, the counter loads the RELOAD value from the LOAD register and then counts down. On reaching 0, it sets the COUNTFLAG to 1 and optionally asserts the SysTick depending on the value of TICKINT. It then loads the RELOAD value again, and begins counting.

0: Counter disabled

1: Counter enabled

### 4.5.2 SysTick reload value register (STK\_LOAD)

Address offset: 0x04

Reset value: 0x0000 0000

Required privilege: Privileged

31	30	29	28	27	26	25	24	23	22	21	20	19	18	17	16
Reserved								RELOAD[23:16]							
								rw	rw	rw	rw	rw	rw	rw	rw
15	14	13	12	11	10	9	8	7	6	5	4	3	2	1	0
RELOAD[15:0]															
rw	rw	rw	rw	rw	rw	rw	rw	rw	rw	rw	rw	rw	rw	rw	rw

Bits 31:24 Reserved, must be kept cleared.

Bits 23:0 **RELOAD**: RELOAD value

The LOAD register specifies the start value to load into the STK\_VAL register when the counter is enabled and when it reaches 0.

Calculating the RELOAD value

The RELOAD value can be any value in the range 0x00000001-0x00FFFFFF. A start value of 0 is possible, but has no effect because the SysTick exception request and COUNTFLAG are activated when counting from 1 to 0.

The RELOAD value is calculated according to its use:

- I To generate a multi-shot timer with a period of N processor clock cycles, use a RELOAD value of N-1. For example, if the SysTick interrupt is required every 100 clock pulses, set RELOAD to 99.
- I To deliver a single SysTick interrupt after a delay of N processor clock cycles, use a RELOAD of value N. For example, if a SysTick interrupt is required after 100 clock pulses, set RELOAD to 99.



### 4.5.3 SysTick current value register (STK\_VAL)

Address offset: 0x08

Reset value: 0x0000 0000

Required privilege: Privileged

31	30	29	28	27	26	25	24	23	22	21	20	19	18	17	16
Reserved								CURRENT[23:16]							
								rw	rw	rw	rw	rw	rw	rw	rw
15	14	13	12	11	10	9	8	7	6	5	4	3	2	1	0
CURRENT[15:0]															
rw	rw	rw	rw	rw	rw	rw	rw	rw	rw	rw	rw	rw	rw	rw	rw

Bits 31:24 Reserved, must be kept cleared.

Bits 23:0 **CURRENT**: Current counter value

The VAL register contains the current value of the SysTick counter.

Reads return the current value of the SysTick counter.

A write of any value clears the field to 0, and also clears the COUNTFLAG bit in the STK\_CTRL register to 0.

### 4.5.4 SysTick calibration value register (STK\_CALIB)

Address offset: 0x0C

Reset value: 0x0000000

Required privilege: Privileged

The CALIB register indicates the SysTick calibration properties.

31	30	29	28	27	26	25	24	23	22	21	20	19	18	17	16	
NO REF	SKEW	Reserved						TENMS[23:16]								
r	r							r	r	r	r	r	r	r	r	r
15	14	13	12	11	10	9	8	7	6	5	4	3	2	1	0	
TENMS[15:0]																
r	r	r	r	r	r	r	r	r	r	r	r	r	r	r	r	

Bit 31 **NOREF**: NOREF flag. Reads as zero. Indicates that a separate reference clock is provided. The frequency of this clock is HCLK/8.

Bit 30 **SKEW**: SKEW flag: Indicates whether the TENMS value is exact. Reads as one. Calibration value for the 1 ms inexact timing is not known because TENMS is not known. This can affect the suitability of SysTick as a software real time clock.

Bits 29:24 Reserved, must be kept cleared.

Bits 23:0 **TENMS[23:0]**: Calibration value. Indicates the calibration value when the SysTick counter runs on HCLK max/8 as external clock. The value is product dependent, please refer to the Product Reference Manual, SysTick Calibration Value section. When HCLK is programmed at the maximum frequency, the SysTick period is 1ms.

If calibration information is not known, calculate the calibration value required from the frequency of the processor clock or external clock.

### 4.5.5 SysTick design hints and tips

The SysTick counter runs on the processor clock. If this clock signal is stopped for low power mode, the SysTick counter stops.

Ensure software uses aligned word accesses to access the SysTick registers.

The SysTick counter reload and current value are undefined at reset, the correct initialization sequence for the SysTick counter is:

1. Program reload value.
2. Clear current value.
3. Program Control and Status register.

### 4.5.6 SysTick register map

The table provided shows the SysTick register map and reset values. The base address of the SysTick register block is 0xE000 E010.

**Table 55. SysTick register map and reset values**

Offset	Register	31	30	29	28	27	26	25	24	23	22	21	20	19	18	17	16	15	14	13	12	11	10	9	8	7	6	5	4	3	2	1	0
0x00	STK_CTRL	Reserved																COUNTFLAG	Reserved										CLKSOURCE	TICKINT	ENABLE		
	Reset Value																	0											1	0	0		
0x04	STK_LOAD	Reserved					RELOAD[23:0]																										
	Reset Value						0	0	0	0	0	0	0	0	0	0	0	0	0	0	0	0	0	0	0	0	0	0	0	0	0	0	0
0x08	STK_VAL	Reserved					CURRENT[23:0]																										
	Reset Value						0	0	0	0	0	0	0	0	0	0	0	0	0	0	0	0	0	0	0	0	0	0	0	0	0	0	0
0x0C	STK_CALIB	Reserved					TENMS[23:0]																										
	Reset Value						0	0	0	0	0	0	0	0	0	0	0	0	0	0	0	0	0	0	0	0	0	0	0	0	0	0	0

## 4.6 Floating point unit (FPU)

The Cortex-M4F FPU implements the FPv4-SP floating-point extension.

The FPU fully supports single-precision add, subtract, multiply, divide, multiply and accumulate, and square root operations. It also provides conversions between fixed xxxxx-point and floating-point data formats, and floating-point constant instructions.

The FPU provides floating-point computation functionality that is compliant with the ANSI/IEEE standard 754-2008, IEEE standard for Binary Floating-Point Arithmetic, referred to as the IEEE 754 standard.

The FPU contains 32 single-precision extension registers, which you can also access as 16 doubleword registers for load, store, and move operations.

[Table 56](#) shows the floating-point system registers in the Cortex-M4F system control block (SCB). The base address of the additional registers for the FP extension is 0xE000 ED00.

**Table 56. Cortex-M4F floating-point system registers**

Address	Name	Type	Reset	Description
0xE000ED88	CPACR	RW	0x00000000	<a href="#">Section 4.6.1: Coprocessor access control register (CPACR) on page 237</a>
0xE000EF34	FPCCR	RW	0xC0000000	<a href="#">Section 4.6.2: Floating-point context control register (FPCCR) on page 237</a>
0xE000EF38	FPCAR	RW	-	<a href="#">Section 4.6.3: Floating-point context address register (FPCAR) on page 239</a>
0xE000EF3C	FPDSCR	RW	0x00000000	<a href="#">Section 4.6.5: Floating-point default status control register (FPDSCR) on page 241</a>
-	FPSCR	RW	-	<a href="#">Section 4.6.4: Floating-point status control register (FPSCR) on page 239</a>

The following sections describe the floating-point system registers whose implementation is specific to this processor.

*Note:* For more details on the IEEE standard and floating-point arithmetic (IEEE 754), refer to the AN4044 Application note. Available from website [www.st.com](http://www.st.com).

### 4.6.1 Coprocessor access control register (CPACR)

Address offset (from SCB): 0x88

Reset value: 0x0000000

Required privilege: Privileged

The CPACR register specifies the access privileges for coprocessors.

31	30	29	28	27	26	25	24	23	22	21	20	19	18	17	16
Reserved								CP11		CP10		Reserved			
								rw		rw					
15	14	13	12	11	10	9	8	7	6	5	4	3	2	1	0
Reserved															

Bits 31:24 Reserved. Read as Zero, Write Ignore.

Bits 23:20 **CPn**: [2n+1:2n] for n values 10 and 11. Access privileges for coprocessor n. The possible values of each field are:

- 0b00: Access denied. Any attempted access generates a NOCP UsageFault.
- 0b01: Privileged access only. An unprivileged access generates a NOCP fault.
- 0b10: Reserved. The result of any access is Unpredictable.
- 0b11: Full access.

Bits 19:0 Reserved. Read as Zero, Write Ignore.

### 4.6.2 Floating-point context control register (FPCCR)

Address offset: 0x04

Reset value: 0xC000000

Required privilege: Privileged

The FPCCR register sets or returns FPU control data.

31	30	29	28	27	26	25	24	23	22	21	20	19	18	17	16	
ASPEN	LSPEN	Reserved														
rw	rw															
15	14	13	12	11	10	9	8	7	6	5	4	3	2	1	0	
Reserved								MONRDY	Reserved	BFRDY	MMRDY	HFRDY	THREAD	Reserved	USER	LSPACT
								rw		rw	rw	rw	rw		rw	rw

- Bit 31 **ASPEN**: Enables CONTROL<2> setting on execution of a floating-point instruction. This results in automatic hardware state preservation and restoration, for floating-point context, on exception entry and exit.  
0: Disable CONTROL<2> setting on execution of a floating-point instruction.  
1: Enable CONTROL<2> setting on execution of a floating-point instruction.
- Bit 30 **LSPEN**:  
0: Disable automatic lazy state preservation for floating-point context.  
1: Enable automatic lazy state preservation for floating-point context.
- Bits 29:9 Reserved.
- Bit 8 **MONRDY**:  
0: DebugMonitor is disabled or priority did not permit setting MON\_PEND when the floating-point stack frame was allocated.  
1: DebugMonitor is enabled and priority permits setting MON\_PEND when the floating-point stack frame was allocated.
- Bit 7 Reserved.
- Bit 6 **BFRDY**:  
0: BusFault is disabled or priority did not permit setting the BusFault handler to the pending state when the floating-point stack frame was allocated.  
1: BusFault is enabled and priority permitted setting the BusFault handler to the pending state when the floating-point stack frame was allocated.
- Bit 5 **MMRDY**:  
0: MemManage is disabled or priority did not permit setting the MemManage handler to the pending state when the floating-point stack frame was allocated.  
1: MemManage is enabled and priority permitted setting the MemManage handler to the pending state when the floating-point stack frame was allocated.
- Bit 4 **HFRDY**:  
0: Priority did not permit setting the HardFault handler to the pending state when the floating-point stack frame was allocated.  
1: Priority permitted setting the HardFault handler to the pending state when the floating-point stack frame was allocated.
- Bit 3 **THREAD**:  
0: Mode was not Thread Mode when the floating-point stack frame was allocated.  
1: Mode was Thread Mode when the floating-point stack frame was allocated.
- Bit 2 Reserved.
- Bit 1 **USER**:  
0: Privilege level was not user when the floating-point stack frame was allocated.  
1: Privilege level was user when the floating-point stack frame was allocated.
- Bit 1 **LSPACT**:  
0: Lazy state preservation is not active.  
1: Lazy state preservation is active. floating-point stack frame has been allocated but saving state to it has been deferred.

### 4.6.3 Floating-point context address register (FPCAR)

Address offset: 0x08

Reset value: 0x0000000

Required privilege: Privileged

The FPCAR register holds the location of the unpopulated floating-point register space allocated on an exception stack frame.

31	30	29	28	27	26	25	24	23	22	21	20	19	18	17	16
ADDRESS[31:16]															
rw															
15	14	13	12	11	10	9	8	7	6	5	4	3	2	1	0
ADDRESS[15:3]													Reserved		
rw															

Bits 31:3 ADDRESS: Location of unpopulated floating-point register space allocated on an exception stack frame.

Bits 2:0 Reserved. Read as Zero, Writes Ignored.

### 4.6.4 Floating-point status control register (FPSCR)

Address offset: Not mapped

Reset value: 0x0000000

Required privilege: Privileged

The FPSCR register provides all necessary user level control of the floating-point system.

31	30	29	28	27	26	25	24	23	22	21	20	19	18	17	16
N	Z	C	V	Reserv ed	AHP	DN	FZ	RMode		Reserved					
rw	rw	rw	rw		rw	rw	rw	rw	rw						
15	14	13	12	11	10	9	8	7	6	5	4	3	2	1	0
Reserved								IDC	Reserved	IXC	UFC	OFC	DZC	IOC	
								rw		rw	rw	rw	rw		

Bit 31 **N**: Negative condition code flag. Floating-point comparison operations update these flags. For more details on the result, refer to [Table 57](#).

- 0: Operation result was positive, zero, greater than, or equal.
- 1: Operation result was negative or less than.

Bit 30 **Z**: Zero condition code flag. Floating-point comparison operations update these flags. For more details on the result, refer to [Table 57](#).

- 0: Operation result was not zero.
- 1: Operation result was zero.

Bit 29 **C**: Carry condition code flag. Floating-point comparison operations update these flags. For more details on the result, refer to [Table 57](#).

- 0: Add operation did not result in a carry bit or subtract operation resulted in a borrow bit.
- 1: Add operation resulted in a carry bit or subtract operation did not result in a borrow bit.

- Bit 28 **V**: Overflow condition code flag. Floating-point comparison operations update this flag. For more details on the result, refer to [Table 57](#).  
 0: Operation did not result in an overflow  
 1: Operation resulted in an overflow.
- Bit 27 Reserved.
- Bit 26 **AHP**: Alternative half-precision control bit:  
 0: IEEE half-precision format selected.  
 1: Alternative half-precision format selected.
- Bit 25 **DN**: Default NaN mode control bit:  
 0: NaN operands propagate through to the output of a floating-point operation.  
 1: Any operation involving one or more NaNs returns the Default NaN.
- Bit 24 **FZ**: Flush-to-zero mode control bit:  
 0: Flush-to-zero mode disabled. Behavior of the floating-point system is fully compliant with the IEEE 754 standard.  
 1: Flush-to-zero mode enabled.
- Bits 23:22 **RMode**: Rounding Mode control field. The specified rounding mode is used by almost all floating-point instructions:  
 0b00: Round to nearest (RN) mode  
 0b01: Round towards plus infinity (RP) mode  
 0b10: Round towards minus infinity (RM) mode  
 0b11: Round towards zero (RZ) mode.
- Bit 21:8 Reserved.
- Bit 7 **IDC**: Input denormal cumulative exception bit. Cumulative exception bit for floating-point exception.  
 1: Indicates that the corresponding exception occurred since 0 was last written to it.
- Bit 6:5 Reserved
- Bit 4 **IXC**: Inexact cumulative exception bit. Cumulative exception bit for floating-point exception.  
 1: Indicates that the corresponding exception occurred since 0 was last written to it.
- Bit 3 **UFC**: Underflow cumulative exception bit. Cumulative exception bit for floating-point exception.  
 1: Indicates that the corresponding exception occurred since 0 was last written to it.
- Bit 2 **OFC**: Overflow cumulative exception bit. Cumulative exception bit for floating-point exception.  
 1: Indicates that the corresponding exception occurred since 0 was last written to it.
- Bit 1 **DZC**: Division by zero cumulative exception bit. Cumulative exception bit for floating-point exception. 1: Indicates that the corresponding exception occurred since 0 was last written to it.
- Bit 0 **IOC**: Invalid operation cumulative exception bit. Cumulative exception bit for floating-point exception. 1: Indicates that the corresponding exception occurred since 0 was last written to it.

**Table 57. Effect of a Floating-point comparison on the condition flags**

Comparison result	N	Z	C	V
Equal	0	1	1	0
Less than	1	0	0	0
Greater than	0	0	1	0
Unordered	0	0	1	1



### 4.6.5 Floating-point default status control register (FPDSCR)

Address offset: 0x0C

Reset value: 0x0000000

Required privilege: Privileged

The FPDSCR register holds the default values for the floating-point status control data.

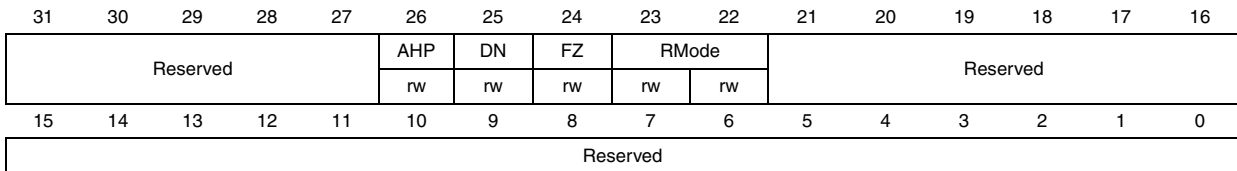

Bits 31:27 Reserved, must be kept cleared.

Bit 26 **AHP**: Default value for FPSCR.AHP

Bit 25 **DN**: Default value for FPSCR.DN

Bit 24 **FZ**: Default value for FPSCR.FZ

Bits 23:22 **RMode**: Default value for FPSCR.RMode

Bits 21:0 Reserved, must be kept cleared.

### 4.6.6 Enabling the FPU

The FPU is disabled from reset. You must enable it before you can use any floating-point instructions.

The example shows an example code sequence for enabling the FPU in both privileged and user modes. The processor must be in privileged mode to read from and write to the CPACR.

#### Example

```

; CPACR is located at address 0xE000ED88
LDR.W  R0, =0xE000ED88
; Read CPACR
LDR    R1, [R0]
; Set bits 20-23 to enable CP10 and CP11 coprocessors
ORR    R1, R1, #(0xF << 20)
; Write back the modified value to the CPACR
STR    R1, [R0]; wait for store to complete
DSB
;reset pipeline now the FPU is enabled
ISB
    
```

### 4.6.7 Enabling and clearing FPU exception interrupts

The FPU exception flags (IDC, UFC, OFC, DZC and additionally, in STM32F3xxx devices, the IXC flag) are ORed and connected to the interrupt controller.



In STM32F4xx devices there is no individual mask and the enable/disable of the FPU interrupt is done at interrupt controller level.

In STM32F3xx devices in addition to the FPU interrupt controller interrupt mask bit, there is an individual mask bit for enabling/disabling the FPU interrupt sources (the IXC flag is masked by default in STM32F3xx devices).

As it occurs very frequently, the IXC exception flag is not connected to the interrupt controller in STM32F4xx devices, and cannot generate an interrupt. If needed, it must be managed by polling.

Clearing the FPU exception flags depends on the FPU context save/restore configuration:

- No floating-point register saving: when Floating-point context control register (FPCCR) Bit 30 LSPEN=0 and Bit 31 ASPEN=0.

You must clear interrupt source in Floating-point Status and Control Register (FPSCR).  
Example:

```
register uint32_t fpscr_val = 0;
fpscr_val = __get_FPSCR();
{ check exception flags }
fpscr_val &= (uint32_t)~0x8F; // Clear all exception flags
__set_FPSCR(fpscr_val);
```

- Lazy save/restore: when Floating-point context control register (FPCCR) Bit 30 LSPEN=1 and Bit 31 ASPEN=X.

In the case of lazy floating-point context save/restore, a dummy read access should be made to Floating-point Status and Control Register (FPSCR) to force state preservation and FPSCR clear.

Then handle FPSCR in the stack.

Example:

```
register uint32_t fpscr_val = 0;
register uint32_t reg_val = 0;
reg_val = __get_FPSCR(); //dummy access
fpscr_val=*(__IO uint32_t*)(FPU->FPCAR +0x40);
{ check exception flags }
fpscr_val &= (uint32_t)~0x8F ; // Clear all exception flags
*(__IO uint32_t*)(FPU->FPCAR +0x40)=fpscr_val;
__DMB() ;
```

- Automatic floating-point registers save/restore: when Floating-point context control register (FPCCR)

Bit 30 LSPEN=0 and Bit 31 ASPEN=1.

In case of automatic floating-point context save/restore, a read access should be made to Floating-point Status and Control Register (FPSCR) to force clear.

Then handle FPSCR in the stack.

Example:

```
// FPU Exception handler
void FPU_ExceptionHandler(uint32_t lr, uint32_t sp)
{
register uint32_t fpscr_val;
if(lr == 0xFFFFF9E9)
{
sp = sp + 0x60;
```

```
    }
    else if(lr == 0xFFFFFFFF)
    {
        sp = __get_PSP() + 0x60 ;
    }
    fpscr_val = *(uint32_t*)sp;
    { check exception flags }
    fpscr_val &= (uint32_t)~0x8F ;    // Clear all exception flags
    *(uint32_t*)sp = fpscr_val;
    __DMB() ;
}
// FPU IRQ Handler
void __asm FPU_IRQHandler(void)
{
    IMPORT FPU_ExceptionHandler
    MOV  R0, LR           // move LR to R0
    MOV  R1, SP           // Save SP to R1 to avoid any modification to
                        // the stack pointer from FPU_ExceptionHandler
    VMRS R2, FPSCR       // dummy read access, to force clear
    B    FPU_ExceptionHandler
    BX   LR
}
```

## 5 Revision history

**Table 58. Document revision history**

Date	Revision	Changes
20-Feb-2012	1	Initial release.
09-Jul-2012	2	<p>Changed reset value in <a href="#">Section 4.6.2: Floating-point context control register (FPCCR)</a>.</p> <p>Added <a href="#">Table 1: Applicable products</a>.</p>
04-Sep-2012	3	<p>Added information on the STM32F3xxx Cortex-M4 processor.</p> <p>Added extra part numbers to <a href="#">Table 1: Applicable products</a>.</p> <p>Added related documentation references to <a href="#">Introduction</a>.</p> <p>Changed "IEEE754-compliant single-precision FPU" bullet in <a href="#">Section 1.3.3: Cortex-M4 processor features and benefits summary</a>.</p> <p>Added information on extended interrupt/event controller to <a href="#">Section 2.5.3: External event input / extended interrupt and event input</a>.</p> <p>Changed first "interrupt" bullet in <a href="#">Section 4.3: Nested vectored interrupt controller (NVIC)</a>.</p> <p>Removed outdated reset value information in <a href="#">Section 4.4.7: Configuration and control register (CCR)</a>, and for 0x14 offset in <a href="#">Table 52: System fault handler priority fields</a>.</p> <p>Added a note about IEEE 754 to <a href="#">Section 4.6: Floating point unit (FPU)</a>.</p>
12-May-2014	4	<p>Updated <a href="#">Reference documents</a>.</p> <p>Updated <a href="#">Section 4.4.1: Auxiliary control register (ACTLR)</a>.</p> <p>Updated <a href="#">Section 4.5.1: SysTick control and status register (STK_CTRL)</a>.</p>

**Please Read Carefully:**

Information in this document is provided solely in connection with ST products. STMicroelectronics NV and its subsidiaries ("ST") reserve the right to make changes, corrections, modifications or improvements, to this document, and the products and services described herein at any time, without notice.

All ST products are sold pursuant to ST's terms and conditions of sale.

Purchasers are solely responsible for the choice, selection and use of the ST products and services described herein, and ST assumes no liability whatsoever relating to the choice, selection or use of the ST products and services described herein.

No license, express or implied, by estoppel or otherwise, to any intellectual property rights is granted under this document. If any part of this document refers to any third party products or services it shall not be deemed a license grant by ST for the use of such third party products or services, or any intellectual property contained therein or considered as a warranty covering the use in any manner whatsoever of such third party products or services or any intellectual property contained therein.

**UNLESS OTHERWISE SET FORTH IN ST'S TERMS AND CONDITIONS OF SALE ST DISCLAIMS ANY EXPRESS OR IMPLIED WARRANTY WITH RESPECT TO THE USE AND/OR SALE OF ST PRODUCTS INCLUDING WITHOUT LIMITATION IMPLIED WARRANTIES OF MERCHANTABILITY, FITNESS FOR A PARTICULAR PURPOSE (AND THEIR EQUIVALENTS UNDER THE LAWS OF ANY JURISDICTION), OR INFRINGEMENT OF ANY PATENT, COPYRIGHT OR OTHER INTELLECTUAL PROPERTY RIGHT.**

**ST PRODUCTS ARE NOT DESIGNED OR AUTHORIZED FOR USE IN: (A) SAFETY CRITICAL APPLICATIONS SUCH AS LIFE SUPPORTING, ACTIVE IMPLANTED DEVICES OR SYSTEMS WITH PRODUCT FUNCTIONAL SAFETY REQUIREMENTS; (B) AERONAUTIC APPLICATIONS; (C) AUTOMOTIVE APPLICATIONS OR ENVIRONMENTS, AND/OR (D) AEROSPACE APPLICATIONS OR ENVIRONMENTS. WHERE ST PRODUCTS ARE NOT DESIGNED FOR SUCH USE, THE PURCHASER SHALL USE PRODUCTS AT PURCHASER'S SOLE RISK, EVEN IF ST HAS BEEN INFORMED IN WRITING OF SUCH USAGE, UNLESS A PRODUCT IS EXPRESSLY DESIGNATED BY ST AS BEING INTENDED FOR "AUTOMOTIVE, AUTOMOTIVE SAFETY OR MEDICAL" INDUSTRY DOMAINS ACCORDING TO ST PRODUCT DESIGN SPECIFICATIONS. PRODUCTS FORMALLY ESCC, QML OR JAN QUALIFIED ARE DEEMED SUITABLE FOR USE IN AEROSPACE BY THE CORRESPONDING GOVERNMENTAL AGENCY.**

Resale of ST products with provisions different from the statements and/or technical features set forth in this document shall immediately void any warranty granted by ST for the ST product or service described herein and shall not create or extend in any manner whatsoever, any liability of ST.

ST and the ST logo are trademarks or registered trademarks of ST in various countries.

Information in this document supersedes and replaces all information previously supplied.

The ST logo is a registered trademark of STMicroelectronics. All other names are the property of their respective owners.

© 2014 STMicroelectronics - All rights reserved

STMicroelectronics group of companies

Australia - Belgium - Brazil - Canada - China - Czech Republic - Finland - France - Germany - Hong Kong - India - Israel - Italy - Japan - Malaysia - Malta - Morocco - Philippines - Singapore - Spain - Sweden - Switzerland - United Kingdom - United States of America

[www.st.com](http://www.st.com)

